

# OPERATION MANUAL

## MITSUBISHI TRANSPORT REFRIGERATION UNIT

**TEK450MA**  
**TEK450SA**  
**TEK350SA**  
**TEK250SA**

This operation manual is intended to provide users with a good knowledge to use Mitsubishi Refrigeration Unit safely.

Operate or service the refrigeration unit only after you have read this manual and understand its contents.

Carefully store this manual in a fixed place so that it is immediately available for your reference when you need it.

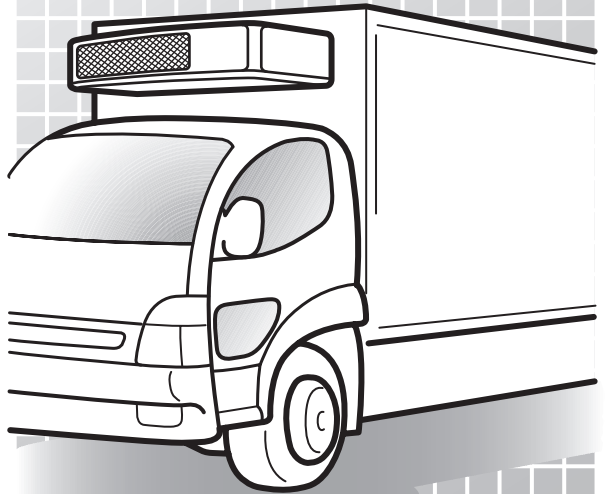

Original Instructions



TSJ012A269



YEAR:2024

# Thank you for your purchase of Mitsubishi Transport Refrigeration Unit.

---

## Purpose of use and application

This Refrigeration Unit is intended to carry the cargo (with the exception of volatile, inflammable, hazardous and corrosive matters) on a transportation vehicle, keeping the inside container temperature at a certain degree.

If the Refrigeration Unit is used for any purposes other than this purpose, it may cause accidents or damages.

---

## Important information

For questions or information, contact your nearest dealer.

- Be sure to follow the contents described in this manual in order to protect yourself and other people from potential risks of this refrigeration unit and to prevent it from getting damaged.
- We are not able to foresee all potential risks of this refrigeration unit or dangers due to mishandling by the customers. Therefore, it is necessary to take measures for safety in addition to the items described in this manual or on warning labels.
- For the following works, contact your nearest dealer. If those works were carried out by customer, the refrigeration unit may lose its performance and we may not be able to ensure the safety of the customer.
  - (a) Installation, modification, specification change and disposal of the refrigeration unit
  - (b) Maintenance of electric appliances
  - (c) Abnormal treatments which are not described in this manual
- This product contains fluorinated greenhouse gases.
  - Refrigerant:R452A(GWP(Global Warming Potential)=2141)  
Refer to a label on unit about weight of fluorinated greenhouse gases and CO<sub>2</sub> equivalent. (  Refer to pages 22.)

---

## Operation manual

- This operation manual is prepared for people who speaks English. In case that person whose native language is not English handles this refrigeration unit, he or she must be instructed on safety by the customer. Furthermore, the warning labels described in their native language must be prepared and stuck on the proper places.
- This operation manual is copyrighted and all rights are reserved by our company. The drawings and technical information described in this manual may not, in whole or part, be published, copied, translated for the purposes other than above-mentioned and reduced to any electronic medium or machine-readable form without prior written consent with our company.
- This manual also contains the explanation of optional specification.
- The contents of this operation manual may differ from that of the refrigeration unit used by a customer due to specification change.
- The contents described in this operation manual may be changed without a prior notice.
- When transferring or lending the refrigeration unit, attach this operation manual together with the unit so that the operators should be able to have a good knowledge on safety.
- Keep this operation manual in the vehicle so that it is available for your reference when you need it.
- Unless otherwise noted, "right" and "left" directions are given as viewed from the front of the refrigeration unit.

---

## For disposal

Contact your nearest dealer when disposing the refrigeration unit. Observe the applicable laws and regulations in your country to dispose refrigerants and cooling water.

---

## Information on the model

This operation manual describes how to use the following model.

### **(1) 2-evaporator system for two refrigeration compartments**

TEK450MA

### **(3) Standard system for single refrigeration compartment**

TEK450SA

TEK350SA

TEK250SA

---

# Contents

---

Purpose of use and application--I	Modification of refrigeration unit and specification change ----- 19
Important information -----I	Power supply equipment ----- 19
Operation manual ----- II	Emergency measure ----- 20
For disposal ----- II	Handling of warning labels ---- 22
Information on the model----- III	Prevention of start during inspection work----- 24
Contents----- IV	Clothing and protective equipment ----- 24
<b>1 Function of Refrigeration Unit----- 1</b>	When abnormal conditions are detected ----- 24
<b>2 Name of each part ----- 2</b>	For emergency----- 24
Arrangement plan for main parts ----- 2	<b>4 Initial setting ----- 25</b>
Condensing unit ----- 3	Display and function of main menu ----- 25
Evaporator unit ----- 4	Language setting mode ----- 26
Alternator ----- 5	Display and function of Sub-menu ----- 27
Battery box ----- 5	Setting the calendar and clock (Date, Month, Year)----- 31
Cabin controller----- 6	Displaying the maintenance information ----- 33
LCD display area ----- 7	Setting the defrost interval ---- 35
Protective devices----- 9	Setting the backup operation time ----- 36
<b>3 Precaution for safety---- 10</b>	Setting LCD backlight----- 37
Signs on safety ----- 10	<b>5 Operation----- 39</b>
Precaution----- 11	Switching the drive----- 40
Handling of high-voltage----- 11	Operating with the vehicle engine -- 40
General precautions ----- 13	Operating with the commercial power ----- 40
During and after the operation ---- 15	Unplug reminder display ----- 40
Inspection/Cleaning/Repair----- 15	Starting the operation----- 41
Loading ----- 16	
Handling of electric equipment and power codes ----- 17	
Reinstallation of refrigeration unit----- 18	

Stopping the operation -----	42		
Suspending (sleep) the compartment operation (2-compartment model) -	43		
Setting the temperature -----	44		
Setting the preset defrost interval and set point -----	45		
Changing the registered preset defrost interval and set point -----	46		
Manual defrost operation-----	48		
Starting the manual defrost operation-----	48		
Ending the manual defrost operation-----	48		
Setting the ON timer -----	49		
Setting the OFF timer -----	51		
Setting the key lock/unlock ---	53		
<b>6 Loading-----</b>	<b>55</b>		
Preparation before loading ----	55		
Loading and unloading -----	56		
Loading procedure-----	56		
Unloading-----	57		
<b>7 Inspection -----</b>	<b>58</b>		
Precautions for inspection ----	58		
Daily inspection-----	60		
Inspection of condenser coil -----	60		
Periodic inspection-----	61		
Periodic inspection check sheet -----	62		
Refrigerant and refrigerating machine oil -----	63		
Power supply system -----	63		
Climate class -----	63		
<b>8 Cautions for use-----</b>	<b>64</b>		
When operating at a low inside container temperature for a long period of time:-----	64		
When stopping the refrigeration unit for a long period of time:-----	64		
<b>9 For emergency -----</b>	<b>65</b>		
Alarm display -----	65		
Switching "Normal display" and "Alarm display" -----	65		
Switching from "Normal display screen" to "Alarm display mode" -----	65		
Switching from "Alarm display mode" to "Normal display screen" -----	65		
Countermeasures-----	66		
When you contact your nearest dealer-----	66		
Resuming operation after an emergency stop -----	66		
List of alarm codes -----	67		

# 1 Function of Refrigeration Unit

This refrigeration unit has following functions.

## (1) Operation during vehicle engine stop

This is the function to operate by battery power during vehicle stop for keeping cargo temperature.

☞ Refer to page 40 for how to switch the operation.

## (2) Switching function of commercial power supply

This is the function to switch the operation automatically depending on whether the commercial power supply is connected or not.

☞ Refer to page 40 for how to switch the operation.

## (3) Defrosting operation function

This is the function to protect evaporator from frosting during cooling operation and to prevent refrigerating power from decreasing.

There are following 2 methods to start defrosting operation.

### 1) Automatic defrosting operation

Defrosting starts automatically by the timer setting.

☞ Refer to page 35 for defrosting timer setting.

### 2) Manual defrosting operation

Defrosting starts forcibly by pressing the switch of controller.

☞ Refer to page 48 for how to operate.

As the defrosting operation is completed, the refrigeration unit returns to the cooling operation.

Defrosting operation will not start when the evaporator temperature is high even during the cooling operation.

## (4) Timer operation function

This is the function to set starting time and stopping time of the operation.

☞ Refer to pages from 49 to 52 for how to set.

## 2 Name of each part

### Main parts

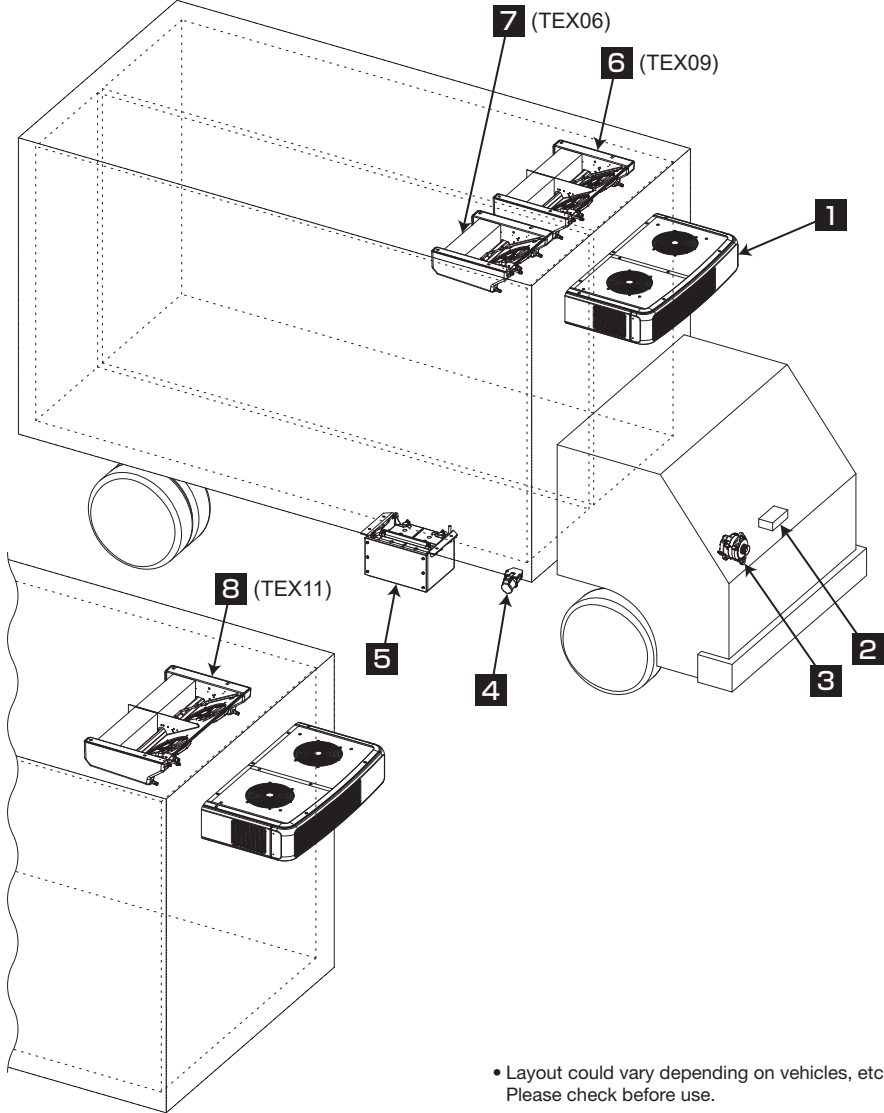

**1** Condensing unit

**2** Cabin controller

**3** Alternator

**4** AC commercial power connector

**5** Battery box

**6** A room evaporator unit

**7** B room evaporator unit

**8** Evaporator unit



## Condensing unit

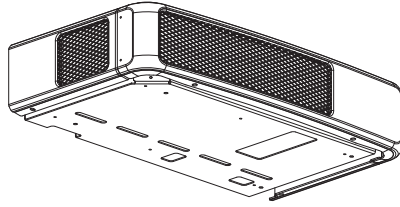

■ Top view

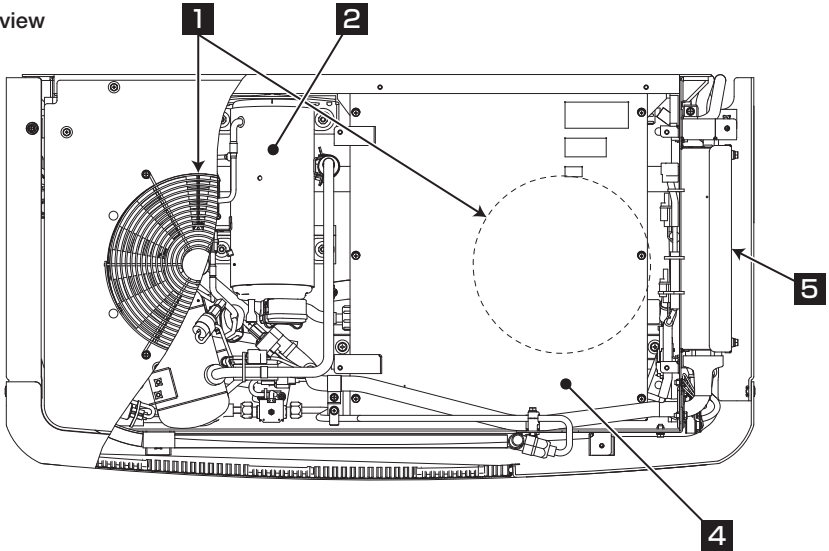

■ Front view

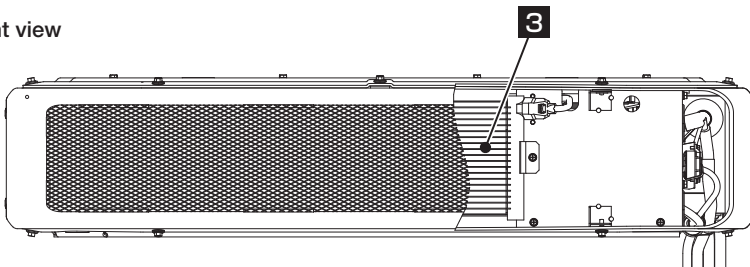

**1** Condenser fan & motor

**2** Compressor

**3** Condenser coil

**4** Control box (power)

**5** Control box (DC)

# Evaporator unit

- TEX11CA-EVA2JE

■ Front view

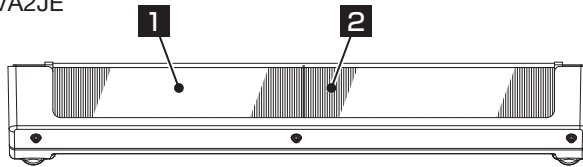

■ Under view

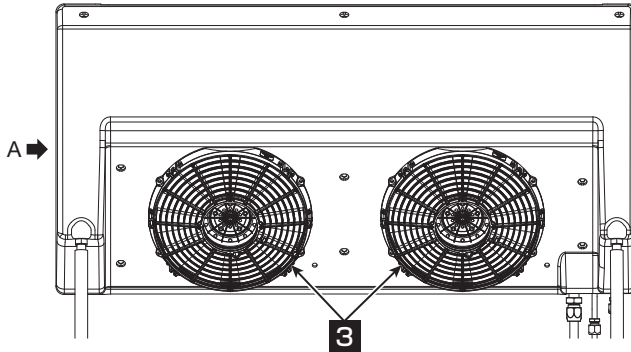

- TEX09CA-EVA2JE

■ Under view

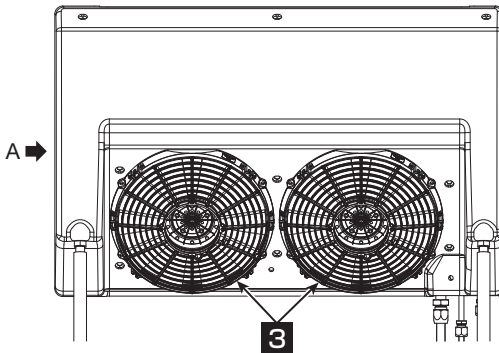

- TEX06CA-EVA2JE

■ Under view

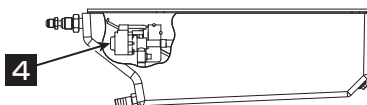
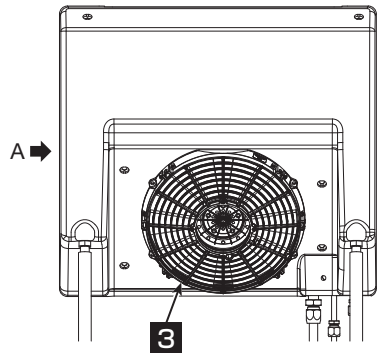

Inside of view "A"

<b>1</b>	Evaporator outlet	<b>3</b>	Evaporator fan motor
<b>2</b>	Evaporator coil	<b>4</b>	Expansion valve

## Alternator

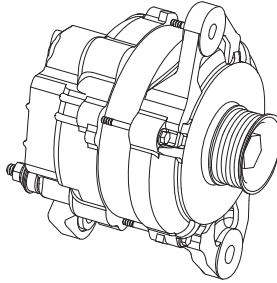

\* Shapes may vary depending on specification changes.

## Battery box

■ Top view

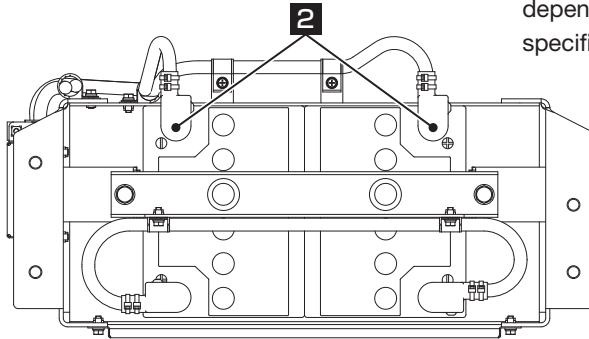

\* Shapes may vary depending on specification changes.

■ Front view

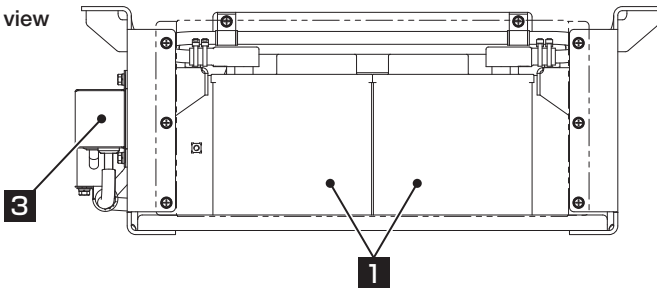

**1** Battery

**3** Fuse box

**2** Battery terminal

# Cabin controller

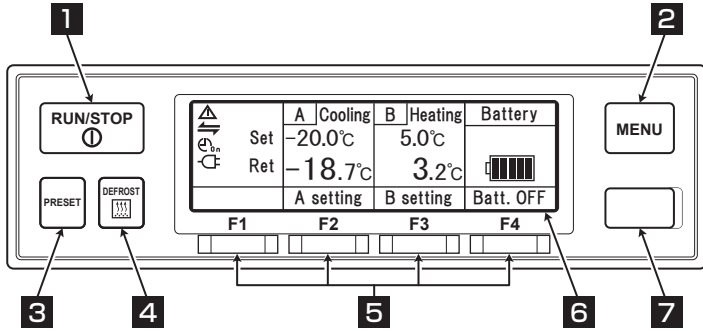

## ■ 1-compartment model

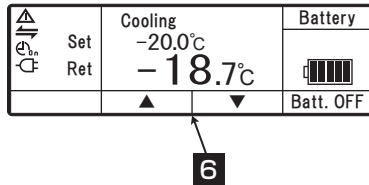





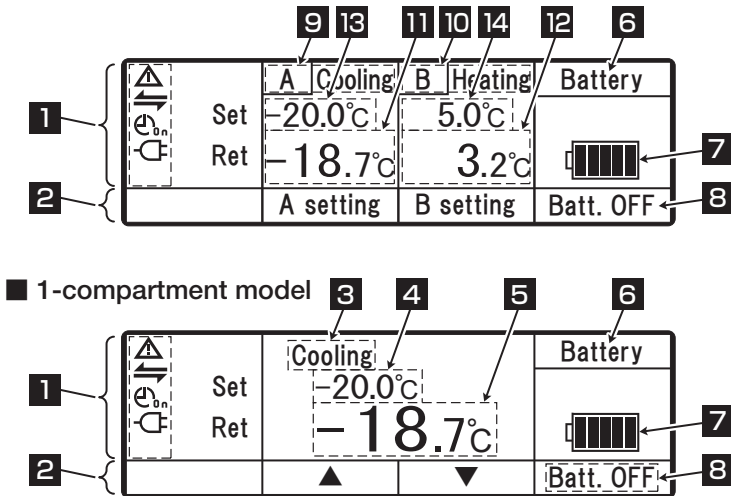

<b>1</b>	<b>RUN/STOP switch</b>	Starts and stops the refrigeration unit.
<b>2</b>	<b>MENU switch</b>	Selects the normal display screen or the menu display screen. Displays the screen while the refrigeration unit is stopped.
<b>3</b>	<b>PRESET switch</b>	Selects the normal display screen or the preset display screen.
<b>4</b>	<b>DEFROST switch</b>	Starts the manual defrost.
<b>5</b>	<b>FUNCTION switches 1 – 4</b>	Functions corresponding to respective setting screens are allocated.
<b>6</b>	<b>LCD</b>	Displays the inside compartment temperature, setting temperature, state of operation, etc.
<b>7</b>	<b>USB terminal (Type B)</b>	Used to read/write data.

## LCD display area



### Description of monitor display item

**1** Monitor displays following items corresponding to respective setting states. The display items light or blink depending on the operation of respective functions.

-  .....Abnormal display  
Lights or blinks when any error occurs.
-  .....Display for the state of external communication.  
Lights when the operation administration input, such as the remote monitor device, etc., is turned ON.
-  .....Displays for ON/OFF timer.  
Lights when the ON timer and the OFF timer are set simultaneously.
-  .....Displays the ON timer.  
Lights when the ON timer operation is set.
-  .....Displays for OFF timer.  
Lights when the OFF timer operation is set.
-  .....Display for commercial power supply.  
Lights when the unit is connected to the commercial power supply.

**2** Displays the allocation of function switch corresponding to the screen.

## 2 Name of each part

- 3** Displays the operation modes.  
<Display contents> Cooling, Heating, Defrost, Sleep, Stop and Fan.  
\* There is no display when Thermostat is OFF with evaporator fan motor OFF.  
Fan is displayed when Thermostat is OFF with evaporator fan motor ON.  
If temperature is out of adequate range, the Cooling or Heating display blinks.

**4** Displays the setting temperature.

**5** Displays the inside compartment temperature.

**6** Displays "Battery".

- 7** Remaining charge of refrigeration unit battery is displayed at 6 steps.  
Lamps extinguish starting from the left most one as the charge depletes.  
If it reaches Charge level 1, it displays "Charge shortage".

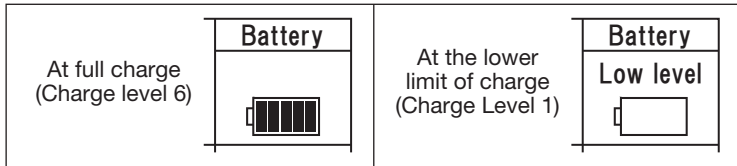

- 8** This indicates the state of battery ON/OFF. When the operation continues with the backup battery, it indicates "Battery ON" or, when it does not, "Battery OFF".

### In case of 2-compartment model

**9** Displays "A" (compartment) and the operation mode of compartment A.

**10** Displays "B" (compartment) and the operation mode of compartment B.

**11** Displays the inside compartment temperature at compartment A.

**12** Displays the inside compartment temperature at compartment B.

**13** Displays the setting temperature at compartment A.

**14** Displays the setting temperature at compartment B.

---

## Protective devices

This refrigeration unit is provided with the following protective devices to ensure the safety of the operators.

(1) Panel, Fan guard

These devices prevent interference with the rotating section (fan motor) during operation.

(2) Commercial power detection function

This function gives a warning buzzer to prevent broken wire of the cable or electric shock if the drive engine is started in a state where the commercial power is supplied.

(3) Others

Protective devices such as high pressure switch are built-into the refrigeration unit. For details, please read the instruction manual.

People who handle this refrigeration unit are requested to understand the functions of these protective devices completely to use it safely. Do not deactivate these protective devices or do not operate the refrigeration unit in the situation that the devices are inactivated. It is most important for safety ensuring to keep functions of the protective devices in normal status continuously.



# 3 Precaution for safety

In this section, necessary safety precautions are provided to prevent accidents resulting in injuries or death, property damages and environment pollution. Read and understand contents of the cautions before starting to use this refrigeration unit.





## Signs on safety

Signs and Symbols on safety in this operation manual and the warning labels call the attention of the people who handle this refrigeration unit.

### Signs on safety

Kinds	Description
 <b>DANGER</b>	Indicates imminent potentially dangerous situation, which if mis-handled, will result in death, injury, or serious accident such as damage of the refrigeration unit.
 <b>WARNING</b>	Indicates dangerous situation, which if mis-handled, could result in death, serious injury, and serious accident such as damage of the refrigeration unit.
 <b>CAUTION</b>	Indicates potentially dangerous situation, which if mis-handle, will result in minor injury or moderate property damage.

### Symbols

Symbols	Description	Symbols	Description
	Never perform.		Always observe the instructions.
	Disconnect power supply plug from socket.		Never touch.
	Repairs and disassembly must be done only by qualified personnel.		

### Other symbol

Other advice for the refrigeration unit is described with the following symbol.

Kind	Description
 NOTE	Useful information for function or performance of equipment



---

## Precaution

---

### Handling of high-voltage

#### **DANGER**



If a high-voltage cable or component is exposed, never touch it.

- Otherwise, it may cause electric shock.

---

To prevent electric shock, do not touch any high-voltage cable, connector, or high-voltage component (control box, etc.).

---



Please maintain a safe distance from the vehicle in case a fire occurs from the refrigeration unit.

Always use a fire extinguisher for electric fire when doing fire fighting.

Do not use water or improper fire extinguishers, it may result in serious injury or electric shock.

---

Do not touch the refrigeration unit or vehicle, in case of accident/damage to unit.

Please contact the nearest dealer and inform the details.

---

#### **WARNING**



When disassembling, removing, or replacing high-voltage cables or components, serious burns or electric shock may occur, causing serious personal injury or death.

Maintenance should only be performed by qualified dealer personnel.

---

 **WARNING**



**If a high-voltage cable or component is exposed, never touch it.**

- Otherwise, it may cause electric shock.

---

**To prevent electric shock, do not touch any high-voltage cable, connector, or high-voltage component (control box, etc.).**



**Please maintain a safe distance from the vehicle in case a fire occurs from the refrigeration unit.**

**Always use a fire extinguisher for electric fire when doing fire fighting.**

**Do not use water or improper fire extinguishers, it may result in serious injury or electric shock.**

---

**Do not touch the refrigeration unit or vehicle, in case of accident/damage to unit. Leave the vehicle, contact the nearest dealer, and inform that the electric drive type refrigeration unit is installed.**

---

**Refrain from attempting any dangerous act such as riding on the unit, hanging on to, grasping, stepping on the unit, or others.**

---

## General precautions

### DANGER



**Do not paint on cover panel. (This will make refrigeration unit out of warranty.)**

- Cracking occurs in panel, which cause a risk of falling down of panel while the vehicle is running.

**Never mistake the polarity of the battery cable.**

- The electrical parts, may get damaged when connecting + and – terminal of battery in reverse.

### WARNING



**Do not modify or perform specification change for the refrigeration and vehicle. (This will make refrigeration unit out of warranty.)**

- It may cause a serious accident if customer modify the refrigeration unit or change the specification by himself/herself.

**Do not start the engine for drive in poorly ventilated places such as an indoor parking lot.**

- Otherwise, it may cause carbon monoxide poisoning due to exhaust gas.

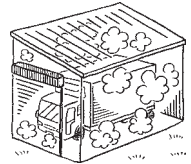

**Do not use the refrigeration unit in the atmosphere which could cause explosion at such place like gas station.**

- Otherwise, it may cause an explosion or a fire.

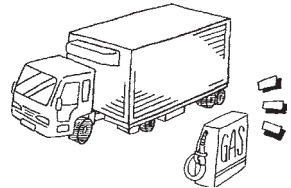

**When it is necessary to charge or retrieve the refrigerant or refrigerating machine oil, be sure to consult the nearest dealer.**

- Customer should refrain from attempting to do these on their own. Otherwise, it could result in serious accident.



**Make sure that no one left inside the container before closing the door.**

- He or she might be frozen to death if the refrigeration unit is operated with someone inside.

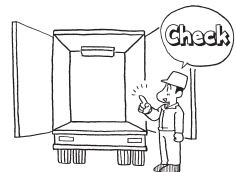

## **WARNING**



**Be sure to carry out the periodic inspections.**

- Otherwise, it may cause troubles of the refrigeration unit or accidents.



---

**Be sure to use a device that emits radio waves (on-vehicle radio device, etc.) within its setting range.**

- When a device with an illegal output is used, this may cause the refrigerator to malfunction or an accident.

---

**The appliance is not to be used by persons (including children) with reduced physical, sensory or mental capabilities, or lack of experience and knowledge, unless they have been given supervision or instruction.**

- It is preferable to perform the monitoring so that a person (including a child) who needs assistances does not use the refrigeration unit alone.

## **CAUTION**



**Do not insert sticks or fingers into cold air outlet or inlet.**

- Otherwise, it may cause trouble on the equipment or injury by the fan.



**Do not climb up, hang down or put your leg onto the refrigeration unit.**

- Otherwise, it may cause damage of the equipment or injury.



**Use the refrigeration unit as the equipment for transport refrigeration.**

- Otherwise, it may deteriorate quality of the cargo if it is used for any other purpose.

---

**When entering the cabinet during loading or unloading of cargos, be sure to wear appropriate clothing or protective gear suitable for the temperature.**

---

## During and after the operation

### CAUTION



**Do not touch the compressor, the refrigerant pipe and movable parts such a fan during operation or immediately after the operation.**

- Otherwise it may cause burns, as compressor and refrigerant pipe will get hot.



**Do not operate the refrigeration unit when it is flooded up to the bottom face of vehicle chassis.**

- It could cause trouble.

## Inspection/Cleaning/Repair

### WARNING



**Do not disassemble and repair by yourself.**

- Otherwise, it may cause damages or an electric shock.

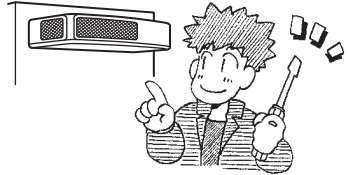

**Do not allow a person (including a child) who needs assistances to perform the inspection, cleaning, or repair without monitoring or instructions.**

**When inspecting or cleaning the refrigeration unit, apply the parking brake and put chocks under wheels.**

- Otherwise, the vehicle may start to move, causing injury or accident.

**When working on the fan motor, make sure to disconnect the fan motor connector before hand.**

### CAUTION



**When refrigerant or refrigerating machine oil has spilled, take care not get it in eyes and avoid accidental contact to skin or inhaling or swallowing.**

- Otherwise, it may cause health disorders such as frostbite, loss of eyesight and pneumonia.

## CAUTION



**Do not wash the refrigeration unit with a steam washer or a high pressure washer.**

- Otherwise, it may cause a rupture due to pressure rise in the refrigeration unit or distortions of the condenser fin.



**Before performing the inspection or cleaning work, stop the refrigeration unit using the RUN/STOP switch, and vehicle switch key off disconnect the battery terminals and the plug of the power cord.**

- Otherwise, it may cause injury or an electric shock due to unexpected start.

## Loading

## WARNING



**Do not load the volatile, inflammable or explosive possibly cargos in the container.**

- Otherwise, it may cause an explosion or a fire.

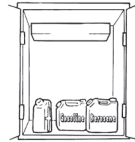

## CAUTION



**Cool down or heat up the cargos to the designated temperature in advance with other refrigerating device.**

- If the cargos are not kept in the designated temperature, it may deteriorate quality of the cargos due to inside container temperature rise.

**Waterproof the cargos if they need to be.**

- Water may drip or splash from the evaporator unit.

**When stacking cargos, secure safety.**

**When loading fragile cargos, use appropriate protective materials.**

- It could damage cargos or cause injury or accident.

## Handling of electric equipment and power codes

### **WARNING**



- Do not splash water on the electric equipment directly or wash it with water.

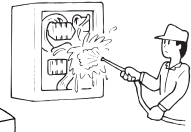

- Do not touch the electric equipment or operate the switches with wet hands.



- Do not modify the power code or apply force on it, by bending it by force, pulling it strongly or twisting it, or do not put cargoes on it.



- Do not wet the electric equipment. In particular, do not wet the electric equipment inside the control box in a rain or snow.

- Do not spill any drink such as coffee or water on the cabin controller.

- Otherwise, it may cause troubles of electric circuit, damages of power supply code or an electric shock.



- Use 3-core cabtyre cables (conductor cross section with 2 mm<sup>2</sup> or more) for power cable. Do not connect it to extension code. (  Refer to page 40.)

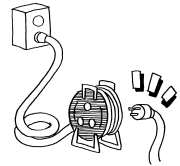

- Pull out the power code by holding the plug part at the end of the code.

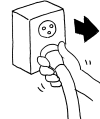

- Check the plug of the power code for dust. If there is no dust, insert it firmly.

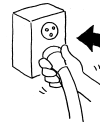

## WARNING



- Surely protect the power socket with a cover when it is not used. When the cover is damaged, repair it immediately.
- Otherwise, it may cause an electric shock or a fire due to the heat, breaking of wire and leaking of water, etc.

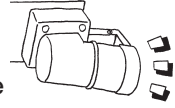

## CAUTION



- Do not start and stop the operation with pulling out or inserting the power supply breaker or power code.**
- Otherwise, it may cause troubles of electric circuit, damages of power supply code or an electric shock.

### Reinstallation of the refrigeration unit

## WARNING



**User should not attempt to move the refrigeration unit to another vehicle. When it is necessary, consult your nearest dealer.**

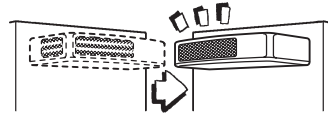

- The refrigeration unit may fall down and cause a serious accident due to improper installation or insufficient strength if the work is performed by the customer.



## Modification of refrigeration unit and specification change

### WARNING



**Do not modify the refrigeration unit or change the specification.**

- It may cause a serious accident if customer modify the refrigeration unit or change the specification by himself/herself.



**Do not use any refrigerant or refrigerating machine oil other than those specified. ( Refer to page 63.)**

- Otherwise, it may cause explosion or fire.

## Power supply equipment

### WARNING



**Be sure to perform the grounding work (PEN) for the electric equipment that supplies the power to the refrigeration unit.**

- If the grounding work is not performed correctly, this may cause a fire.

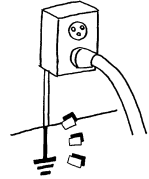

**Be sure to perform the electrical construct work in accordance with IEC 60364 and use the dedicated circuits and overcurrent circuit breakers.**

- It may cause an electric shock or a fire if there is capacity shortage of electric circuit.

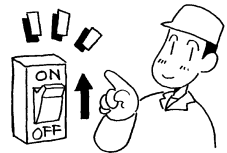

## Emergency measure

### (1) Refrigerant

- **When refrigerant got in your eye**

Wash your eye with lots of clean running water for more than 15 minutes immediately. Wash rear side of the eyelid as well. Then, consult a physician as soon as possible.

- **When refrigerant comes in contact with your skin**

Take off wet clothes, shoes and socks immediately, as it may cause frostbite if you touch the refrigerant. Wash the part well with lots of water. If you still have irritation, consult a physician as soon as possible.

- **When inhaling evaporated gas**

When someone inhaled high level of gas, move to the place with fresh air immediately holding him/her with a blanket or the like to keep warm. Then consult a physician as soon as possible. When he/she does not breathe or hardly breathe, loosen his/her clothes and practice artificial respiration after securing the air passage. Depending on the circumstance, have him/her inhale oxygen and take him/her to a physician as soon as possible.

- **When swallowing refrigerant**

Do not throw up by force and consult a physician as soon as possible.

- \* **Precautions for physician**

Use of Catecholamine system medicine such as adrenaline and so on may cause heart arrhythmia. Therefore it is required to use only for the emergency life-sustaining treatment with special consideration.

### (2) Compressor oil

- **When compressor oil got in your eye**

Wash your eye with lots of clean running water for more than 15 minutes immediately. Wash rear side of the eyelid as well. If you still have irritation, consult a physician as soon as possible.

- **When compressor oil comes in contact with your skin**

Wash the part with lots of water and soap well and apply conditioning cream on it.

- **When inhaling evaporated gas**

Move to the place with fresh air immediately holding him/her with a blanket or the like to keep warm. Then consult a physician if it is necessary. When he/she does not breathe or hardly breathe, loosen his/her clothes and practice artificial respiration after securing the air passage. Depending on the circumstance, have him/her inhale oxygen and take him/her to a physician as soon as possible.

● **When swallowing compressor oil**

Do not throw up the oil by force and consult a physician as soon as possible. When inside the mouth is contaminated, wash it well with water. (When throwing up the oil by force, it easily gets into air passage and causes high fever if it gets into lung. It may cause hardly incurable hemorrhagic pneumonia accordingly.)

# Handling of warning labels

- (a) Important precautions are stated on the warning labels. Never operate the refrigeration unit unless fully understanding the meanings of the warning labels. When you found some difficulties to understand, contact your nearest dealer.
- (b) Always keep the labels in good condition to read. Do not peel off, tear off or damage the labels or do not wipe with solvent or paint them.
- (c) When the labels become illegible, purchase them from your nearest dealer and change them.

## Vehicle

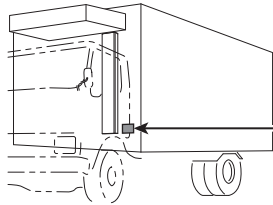

**Label (F-Gas)**

(EN) This Product contains fluorinated greenhouse gases. (DE) Dieses Produkt enthält fluorhaltige Treibhausgase. (FR) Questo prodotto contiene GAS fluorizzati ad effetto serra. (ES) Este producto contiene gases fluorados de efecto invernadero. (SE) Denna produkt innehåller fluorerade växthusgasar.	
Refrigerant - Kältemittel - Refrigerante - Refrigerante - Kältemedium GWP(Global Warming Potential) = 2141	R452A
Total Charge - Gesamte Füllmenge - Quantità totale - Cargo total - Total infundomängd	[ ] kg
Total Weight of CO <sub>2</sub> equivalent - Gesamtgewicht CO <sub>2</sub> -Äquivalent - Peso totale espresso in Tonnellate di CO <sub>2</sub> equivalenti - Pesa total equivalente de CO <sub>2</sub> - Mängd kollektiväkvivalenter CO <sub>2</sub>	[ ] (x 2.141) t
TSJ011M007B	

## Condensing unit

■ Top view

**PSA011H011A** (Warning: Hot surface)

**TSJ011H113** (Warning: Radioactive hazard)

**Control box (power)** (Warning: High Voltage - Hazard of severe electrical shock or burn. Disconnect power before opening cabinet door.)

**TSJ011H110**

**PSA011H011** (Warning: High Voltage - Electrical shock)

**Control box (DC)**

**View "A"**

**View "B"**

**TSJ011H072T** (Sound power level: L<sub>WA</sub> 94 dB)

**Inside of view "A"**

## Evaporator unit

### ■ Bottom view

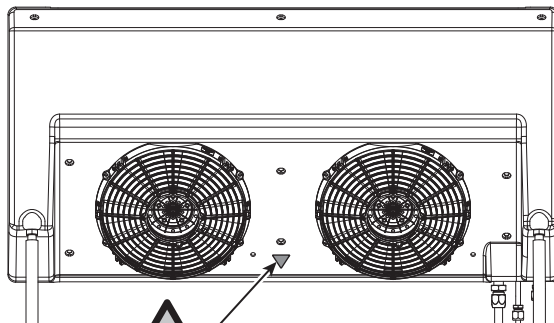

TSJ011H113

## Prevention of start during inspection work

When several people are working simultaneously for inspection, it is necessary to protect them from getting injured by accidental start of operation.

In such occasion, place a tag stating "WORKING" on the cabin controller.

---

## Clothing and protective equipment

Wear proper clothing and protective equipment to prevent from getting injured.

- Wear the clothing such as long sleeves, long pants, gloves and eye protections.
  - Do not wear accessories such as necklaces or a necktie to prevent it from getting rolled in. Fasten the cuffs firmly.
  - When entering the cabinet during loading or unloading of cargos, be sure to wear appropriate clothing or protective gear suitable for the temperature.
- 

## When abnormal conditions are detected

Refer to "9 For emergency" when abnormal conditions are detected. Please contact your nearest dealer when it is too difficult to handle.

---

## For emergency

Contact the public agencies such as the police or the fire department immediately when an accident could result in serious injury, death, serious property damage or environmental damage occurred. Contact your nearest dealer to prevent second accident.

# 4 Initial setting

## Display and function of main menu

If you press the “MENU” switch once on the “Normal display screen” which is displayed when the refrigeration unit is stopped or operating, the display changes to the “Main menu” screen. Each push on “F2 (▲)” or “F3 (▼)” switch changes the display so that various settings can be made. In the following figure, “F2” switch changes sequence clockwise while “F3” switch changes counter clockwise.

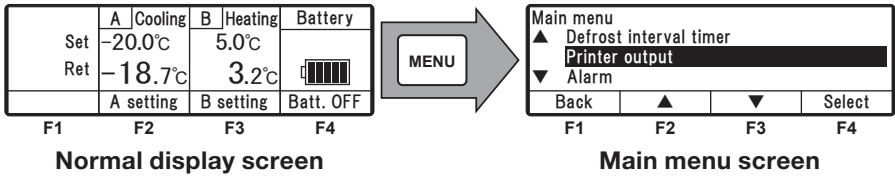

• Main menu items

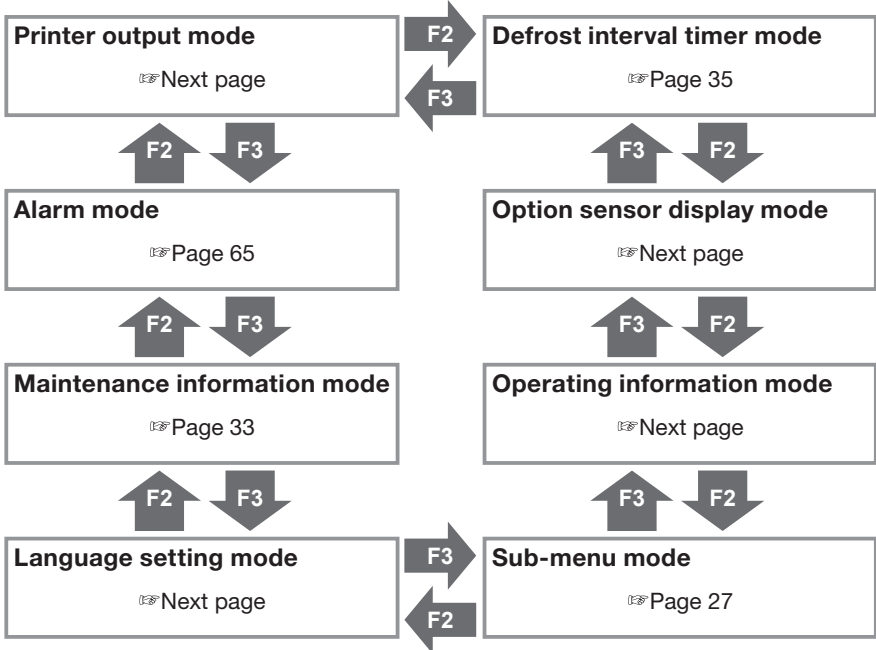

## 4 Initial setting

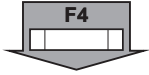

If you press “F4 (Select)” switch on each MAIN menu screen on previous page, the display changes to the following screens.

Printer output			
Printout period	12Hr		
Temp range	±30°C		
Center temp	0°C		
Back	▲	▼	Next

### Printer output setting mode

The temperature graph is printed in this mode. Provide a printer to print the graph. (Option)

Alarm1			
E010	16 Jan 2022 07:10		
E016	15 Jan 2021 08:15		
E013	30 Nov 2020 10:30		
Back		Clear	Next

### Alarm display mode

Up to 5 error codes and dates/times of alarm occurred are displayed. These are cleared by pressing “F3 (Clear)” switch.

(☞ Page 65)

Maintenance information			
Unit operation time/2120Hr			
Back			Next

### Maintenance information display mode

Operation time and number of operations of each device are displayed in this mode.

(☞ Page 33)

Language setting			
▲	German		
	English		
▼	French		
Back	▲	▼	Set
F1	F2	F3	F4

### Language setting mode

Selects a language (English, French, Italian, Swedish or German). Press “F2 (▲)” or “F3 (▼)” switch to select a language, and finalize the selection by pressing “F4 (Set)” switch.

Sub-menu			
▲	BDS function setting		
	Calendar and clock setting		
▼	Set On Timer		
Back	▲	▼	Select

### Sub-menu selection mode

Functions of the controller operability, or other, are displayed and set in this mode.

(☞ Page 27)

Operating information1 C000			
HP	---	TD	125°C
LP	150kPa	REV	90rps
Batt	27.6V		
Back	Unlock	Lock	Next

### Operation information display mode

State of operation is displayed in this mode.



Operating information2			
State	A	Cooling	B Heating
EVT	-24°C		

\* 1-compartment model

Operating information2	
State	Cooling
EVT	-24°C

Option sensor display			
-20.7°C			
Back			

### Option sensor temperature display mode

When the optional sensor is installed, the sensor temperature is displayed in this mode. Unless the option sensor is installed, it displays “Lo”.

Current setting			
6.0Hr			
Back	▲	▼	Set

### Defrost interval timer setting mode

The defrost interval is displayed and set in this mode. It is set at “6.0Hr” at the shipping from factory.

(☞ Page 35)



## Display and function of Sub-menu

On the “Sub-menu”, the screen changes in the following order at each push on “F2 (▲)” or “F3 (▼)” switch. In the following figure, “F2” switch changes sequence clockwise while “F3” switch changes counter clockwise.

### NOTE

- If “MENU” switch is pressed for more than 1 second on the way of changing setting, the display returns to the normal display screen, and the change content is not reflected. The change content will be lost also when the setting change is aborted on the way.

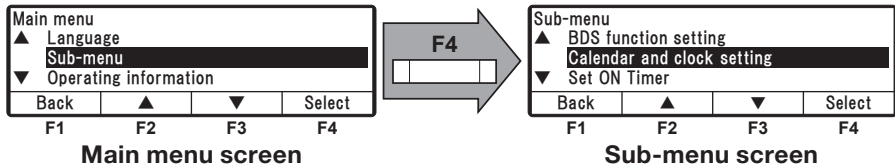

### • Sub-menu items

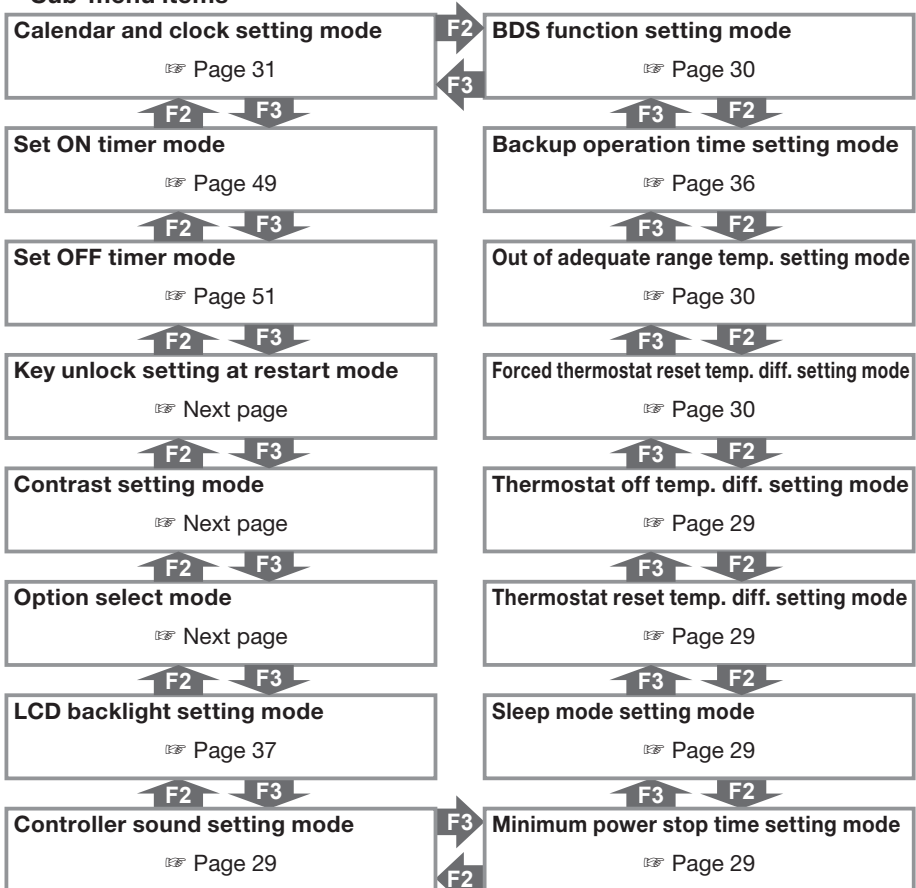

## 4 Initial setting

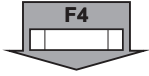

If “F4 (Select)” switch is pressed on each Sub-menu screen on previous page, the display changes to following screens.

Calendar and clock setting			
01 Jan 2022 00:00			
Back	▲	▼	Next

### Calendar and clock setting mode

Date, Month, Year and current time are set in this mode.

(☞ Page 31)

Set ON timer			
ON timer disable			
Back	Enable	Disable	Set

### Set ON timer mode

Date and time to start the refrigeration unit automatically is set in this mode.

(☞ Page 49)

Set OFF timer			
OFF timer disable			
Back	Enable	Disable	Set

### Set OFF timer mode

Date and time to stop the refrigeration unit automatically is set in this mode.

(☞ Page 51)

Key unlock setting at restart			
ON			
Back	ON	OFF	Set
F1	F2	F3	F4

### Key unlock setting at restart mode

Key unlock at restart is set in this mode.

Press “F2 (ON)” or “F3 (OFF)” switch to select ON or OFF, and press “F4 (Set)” switch to finalize the selection.

(Default: ON)

ON: Key lock is cancelled when RUN/STOP switch is turned ON and OFF.

OFF: Key lock is NOT cancelled even when RUN/STOP switch is turned ON and OFF.

Contrast setting			
Back	▲High	▼Low	Set
F1	F2	F3	F4

### Contrast setting mode

Screen contrast is adjusted in this mode.

Use “F2 (▲)” switch to intensify the contrast or “F3 (▼)” switch to diminish the contrast.

Option select			
Option1 setting		OFF	
Back	Previous	Next	Select

### Option select/set mode

Press “F2 (Previous)” or “F3 (Back)” switch to select options 1 to 8.

Press then “F4 (Select)” switch to change to Option1 (~ 8) setting mode. Press then “F2 (ON)” or “F3 (OFF)” switch to select ON or OFF, and press “F4 (Set)” switch to finalize the selection.

Option1 setting			
OFF			
Back	ON	OFF	Set
F1	F2	F3	F4

LCD backlight setting			
▲ Always ON			
Light SW linked			
▼ Lit at key operation only(20sec)			
Back	▲	▼	Select

**LCD backlight setting mode**

LCD backlight is set in this mode.

(☞ Page 37)

Controller sound setting			
ON			
Back	ON	OFF	Set
F1	F2	F3	F4

**Controller sound setting mode**

Whether the switch operating sound is turned on or off is set in this mode.

Select ON or OFF by pressing “F2 (ON)” or “F3 (OFF)” switch, and finalize the selection by pressing “F4 (Set)” switch.

Minimum power stop time setting			
8min			
Back	▲	▼	Set

**Minimum power stop time setting mode**

Setting minimum time before starting operation after thermostat OFF to improve power consumption by reducing frequent starting actions. (Setting option)

1~30 minutes, which can be changed minute by minute.

(Default: 8 minutes)

Sleep mode setting			
Disable			
Back	Enable	Disable	Set

**Sleep mode setting mode**

Starting the refrigeration unit automatically by commercial power connection is set in this mode. Select enable or disable by pressing “F2 (Enable)” or “F3 (Disale)” switch, and finalize the selection by pressing “F4 (Set)” switch.

Thermostat reset temp. diff. setting			
Default			
Back	▲	▼	Set

**Thermostat reset temp. diff. setting mode**

Setting of temperature difference between set temperature and return air temperature in order to return to operation (thermostat ON). Setting is 0~6°C which can be changed in the unit of 0.5°C. [Default (2°C) at shipping]

**[2-compartment model]**

Select Zone A or B before setting by pressing “F2 (A setting)” or “F3 (B setting)” switch.

Thermostat reset temp. diff. setting			
Zone A:Default		Zone B:1.5°C	
Back	A setting	B setting	
F1	F2	F3	F4

Thermostat off temp. diff. setting			
0.5°C			
Back	▲	▼	Set

**Thermostat OFF temp. diff. setting mode**

Setting of temperature difference between set temperature and return air temperature in order to return to operation (thermostat OFF). Setting is 0~6°C which can be changed in the unit of 0.5°C. [Default (1°C) at shipping]

**[2-compartment model]**

Same as previous mode.

## 4 Initial setting

Forced thermostat reset temp. diff. setting			
4.0°C			
Back	▲	▼	Set

### Forced thermostat reset temp. diff. setting mode

Setting temperature difference from target temperature to be used as forced thermostat restarting condition after thermostat OFF.

(Setting option)

2~10°C which can be changed in the unit of 0.5°C.  
(Default: 4°C)

Out of adequate range temp. setting			
4.0°C			
Back	▲	▼	Set

### Out of adequate range temp. setting mode

Setting allowable return air temperature range against set temperature. Setting is 1~5°C which can be changed in the unit of 1.0°C. (5°C at shipping and OFF is selectable)

Backup operation time setting			
30min			
Back	▲	▼	Set

### Backup operation time setting mode

The backup operation time is displayed and set in this mode. It is set at “30min” at the shipping from factory. (☞ Page 36)

BDS function setting			
ON			
Back	ON	OFF	Set
F1	F2	F3	F4

### BDS function setting mode (Option)

BDS function is set in this mode.

BDS (Body Door Switch) function runs or stops the unit when the door of the van body is opened or closed.

Press “F2 (ON)” or “F3 (OFF)” switch to select ON or OFF, and press “F4 (Set)” switch to finalize the selection.

## Setting the calendar and clock (Date, Month, Year)

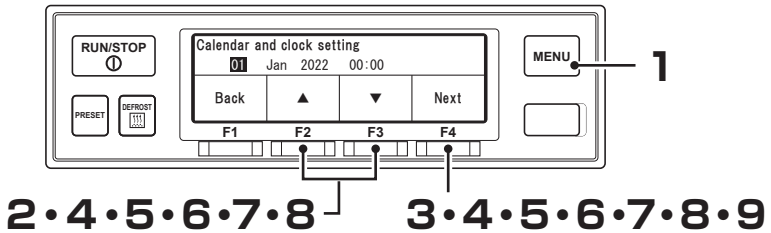

### 1 Press "MENU" switch.

⇒ The display changes to "Main menu" screen.

### 2 Press "F2 (▲)" or "F3 (▼)" switch till "Sub-menu" screen is displayed.

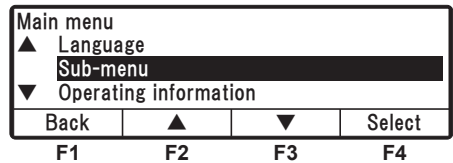

### 3 Press "F4 (Select)" switch to change to "Sub-menu" screen (Right figure).

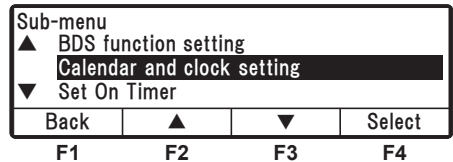

### 4 Press "F4 (Select)" switch to change to "Calendar and clock setting" mode (Right figure).

⇒ Press "F2 (▲)" or "F3 (▼)" switch to adjust at current date.

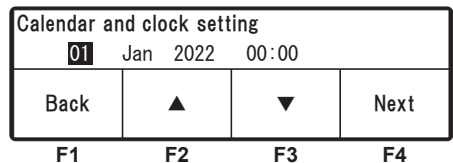

### 5 Press "F4 (Next)" switch.

⇒ Press "F2 (▲)" or "F3 (▼)" switch to adjust at current month.

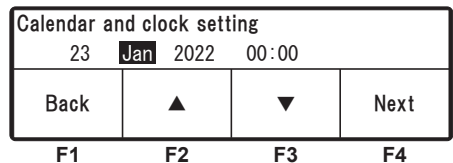

### 6 Press "F4 (Next)" switch.

⇒ Press "F2 (▲)" or "F3 (▼)" switch to adjust at current year.

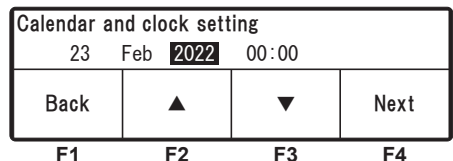

#### 4 Initial setting

### 7 Press “F4 (Next)” switch.

⇒ Press “F2 (▲)” or “F3 (▼)” switch to adjust at current time (Hour).

Calendar and clock setting			
23 Feb 2022 00:00			
Back	▲	▼	Next
F1	F2	F3	F4



#### NOTE

- Time is displayed in the 24-hour scale. If it is “7 PM”, set as “19:00”.

### 8 Press “F4 (Next)”.

⇒ Press “F2 (▲)” or “F3 (▼)” switch to adjust at current time (Minute).

Calendar and clock setting			
23 Feb 2022 09:00			
Back	▲	▼	Set
F1	F2	F3	F4

### 9 Press “F4 (Set)” switch.

⇒ The setting is completed, and the display returns to the screen of Step 3, “Sub-menu”.

## Displaying the maintenance information

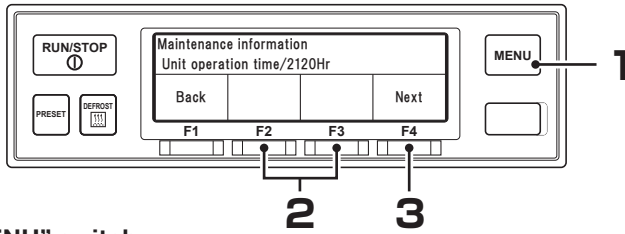

### 1 Press "MENU" switch.

⇒ The display changes to the "Main menu" screen.

### 2 Press "F2 (▲)" or "F3 (▼)" switch till the display changes to the "Maintenance information" mode.

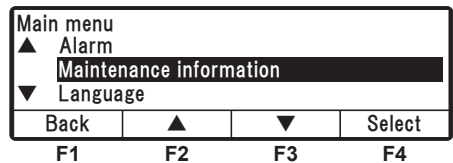

### 3 Press "F4 (Select)" switch.

⇒ "Unit operation time" is displayed.

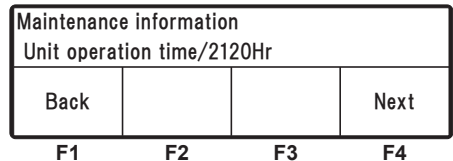

## Display of Time to replace parts

- If the operation time or number of operations reaches the Maintenance required time on each device, this screen (Right figure) is displayed for 10 seconds after the start of operation of the refrigeration unit.
- If you press "F4 (Next)" switch, the display changes to each parts in the table next page. In case part other than listed in the table is displayed when pressing "F4 (Next)", it is the maintenance required part. The replacement of part that is listed in the table should be done based on the interval of the table.
- If you press "F2 (Reset)" switch after replacing the part, the operation time and the number of START/STOP cycles are cleared.

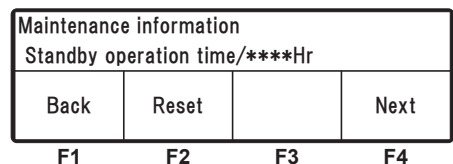
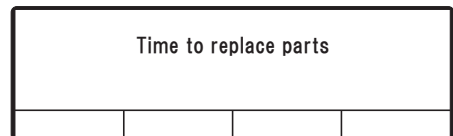

#### 4 Initial setting

- If you press “F4 (Next)” switch, the display changes to each display item in the table below.

	Display item
1	Unit operation time
2	Generator operation time
3	Standby operation time
4	Discharge current integration



## Setting the defrost interval

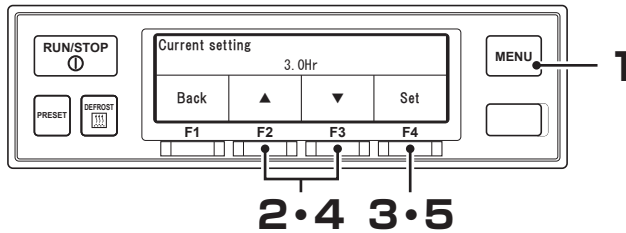

### 1 Press "MENU" switch.

⇒ The display changes to "Main menu" screen.

### 2 Press "F2 (▲)" or "F3 (▼)" switch till the display changes to "Defrost interval timer".

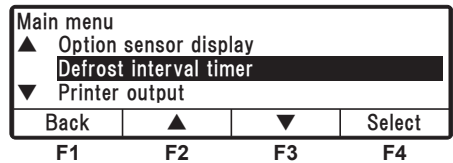

### 3 Press "F4 (Select)" switch.

⇒ Current setting of "Defrost interval time" is displayed.

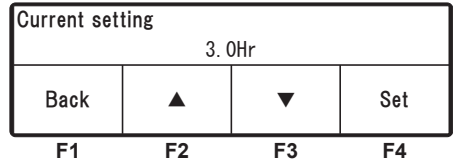

### 4 Press "F2 (▲)" or "F3 (▼)" switch to select a setting time.

#### NOTE

- The defrosting can be set at OFF, or at every 30-minute in the range of from 0.5 hours to 6 hours.

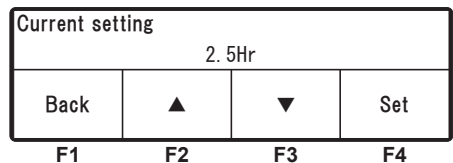

### 5 Press "F4 (Set)" switch.

⇒ The setting completes, and the display returns to the screen of Step 2, "Main menu".

## Setting the backup operation time

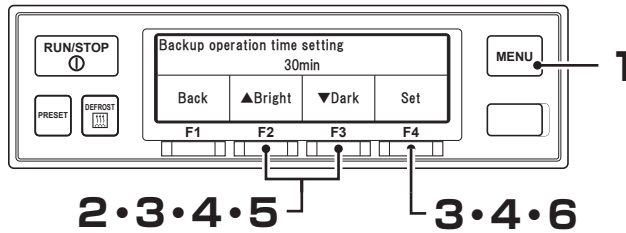

**1** Press “MENU” switch.

⇒ The display changes to “Main menu” screen.

**2** Press “F2 (▲)” or “F3 (▼)” switch till the display changes to “Sub-menu” screen (Right figure).

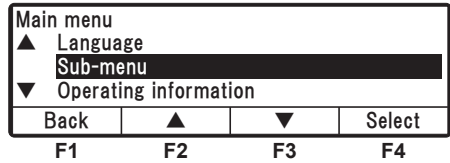

**3** Press “F4 (Select)” switch to change to “Sub-menu” screen. Press “F2 (▲)” or “F3 (▼)” switch till the display changes to “Backup operation time setting” screen (Right figure).

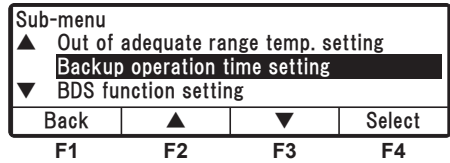

**4** Press “F4 (Select)” switch.

⇒ Current setting of “Backup operation time setting” is displayed.

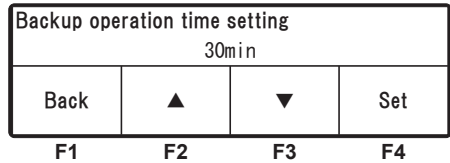

**5** Press “F2 (▲)” or “F3 (▼)” switch to select a setting time.

**NOTE**

- The backup operation time can be set at 10 min, 20 min, 30 min, 40 min, 50 min, 60 min, or OFF (Continuing the backup operation). It is set at “30 min” at the shipping from factory.

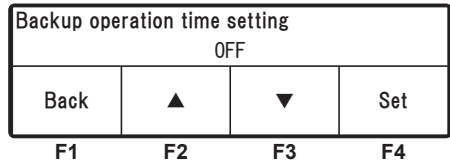

**6** Press “F4 (Set)” switch.

⇒ The setting completes, and the display returns to “Sub-menu” screen of Step 3.

## Setting LCD backlight

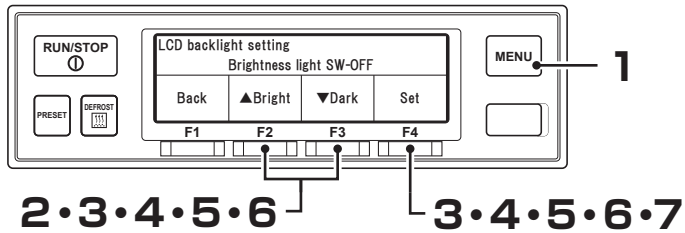

### 1 Press "MENU" switch.

⇒ The display changes to "Main menu" screen.

### 2 Press "F2 (▲)" or "F3 (▼)" switch till the display changes to "Sub-menu" screen (Right figure).

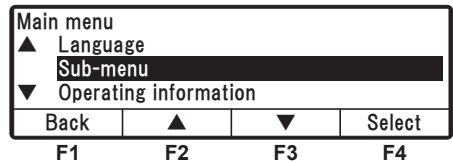

### 3 Press "F4 (Select)" switch to change to "Sub-menu" screen. Press "F2 (▲)" or "F3 (▼)" switch till the display changes to "LCD backlight setting" screen (Right figure).

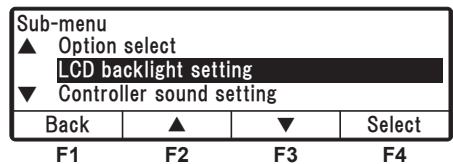

### 4 Press "F4 (Select)" switch.

⇒ Press "F2 (▲)" or "F3 (▼)" switch to select the following LCD backlight setting.

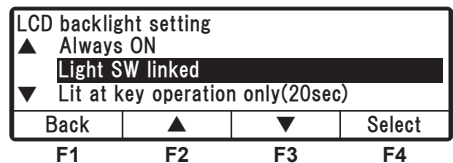

- [Light SW linked] : Lights interlocked with the lighting of vehicle's light.  
 [Lit at key operation only(20sec)] : Lights for 20 seconds only when the switch is operated.  
 [Always OFF] : Always turning off the light.  
 [Always ON] : Always lighting.

#### 4 Initial setting

### 5 Press “F4 (Select)” switch. 【Light SW linked】

- ⇒ Adjust the brightness of the LCD backlight, when the vehicle’s light is OFF, pressing “F2 (▲Bright)” or “F3 (▼Dark)” switch.  
⇒ Step 6

【Lit at key operation only(20sec)】

- ⇒ Step 7

【Always OFF】

- ⇒ Step 7

【Always ON】

- ⇒ Adjust the brightness of the LCD backlight for Always ON by pressing “F2 (▲Bright)” or “F3 (▼Dark)” switch. ⇒ Step 7

### 6 Press “F4 (Next)” switch. 【Light SW linked】

- ⇒ Adjust the brightness of the LCD backlight, when the vehicle’s light is ON, pressing “F2 (▲Bright)” or “F3 (▼Dark)” switch. ⇒ Step 7

### 7 Press “F4 (Set)” switch.

- ⇒ The setting completes, and the display returns to “Sub-menu” screen of Step 3.

LCD backlight setting			
Brightness of light SW-OFF			
Back	▲Bright	▼Dark	Next
F1	F2	F3	F4

LCD backlight setting			
Lit at key operation only(20sec)			
Back			Set
F1	F2	F3	F4

LCD backlight setting			
Always OFF			
Back			Set
F1	F2	F3	F4

LCD backlight setting			
Brightness of always ON			
Back	▲Bright	▼Dark	Set
F1	F2	F3	F4

LCD backlight setting			
Brightness of light SW-OFF			
Back	▲Bright	▼Dark	Set
F1	F2	F3	F4

## 5 Operation

### **WARNING**



**Do not operate the refrigeration unit in the place where there is a risk of combustible gas leakage.**

- Otherwise, it may cause a fire.
- 

**Do not touch the electric devices with wet hands.**

- Otherwise, it may cause an electric shock.
- 

**Do not operate the cabin controller while driving the vehicle.**

- Otherwise, it could result in serious accident.
- 



**When driving the unit with the vehicle's engine in a building, sufficient ventilation must be provided.**

- Otherwise, it may cause oxygen deficiency due to exhaust gas.
-

## Switching the drive

The refrigeration unit switches between the vehicle engine drive and the commercial power drive by detecting automatically, at the start of operation, whether it is connected to the commercial power supply or not.

### Operating with the vehicle engine

- 1 Make sure that the commercial power supply is not connected to the AC commercial power connector.

### Operating with the commercial power

#### **WARNING**



- Use 3-core cabtyre cables (conductor cross section with 2 mm<sup>2</sup> or more) for power cable. Do not connect it to extension code.**
- Otherwise, it may cause an electric shock or a fire due to the heat and breaking of wire.



#### **CAUTION**



- Use 1-phase AC230V 50Hz for power supply.**
- It may cause damage of the refrigeration unit or a fire if any other power supply is used.

- 1 **Connect the AC commercial power connector to the commercial power supply. (For the specification of power supply system, refer to page 63.)**

⇒ Commercial power supply icon lights.

	A	Cooling	B	Heating	Battery
	Set	-20.0°C		5.0°C	
Ret	-18.7°C		3.2°C		
	A setting		B setting		Batt. OFF



### Unplug reminder display

If the commercial power supply is connected while the vehicle's engine is running (IG-ON), or the start key of vehicle's engine is turned ON (IG-ON) while the commercial power supply is connected, the buzzer sounds, showing the figure at left. Select either one from the above to drive the refrigeration unit.

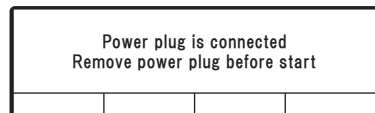

## Starting the operation

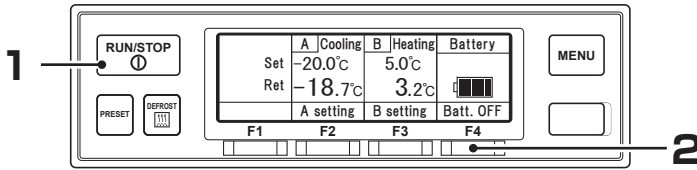

### 1 Press “RUN/STOP” switch. (The refrigeration unit is turned “ON”.)

⇒ LCD indicates the inside compartment temperature and the setting temperature.

When the unit is connected to the commercial power supply, LCD indicates the display for commercial power supply.

### 2 [Backup operation when the vehicle is stopped] Press “F4 switch (Batt. OFF)”.

⇒ “Batt. ON” (right figure) is displayed, and it is switched to the backup operation which takes the power from the battery special to the refrigeration unit.

⇒ If you press “F4 switch (Batt. ON)” once more, it returns to normal operation.

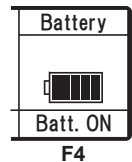

#### NOTE

- Length of backup operation can be changed with the backup operation time setting. When the backup operation time is set at “OFF”, the backup operation continues till the battery charge is used up completely. (☞ Page 36)
- If it turns to IG-OFF with the battery ON, the buzzer sounds 3 times to indicate the continuation of battery operation.

## Stopping the operation

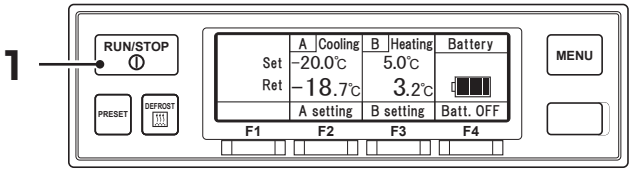

- 1 Press “RUN/STOP” switch.  
(The refrigeration unit is turned “OFF”.)

**NOTE**

- If, after stopping the motor, the vehicle drive engine is started in the state that the commercial power supply is connected, the buzzer sounds to remind to turn off the power supply.



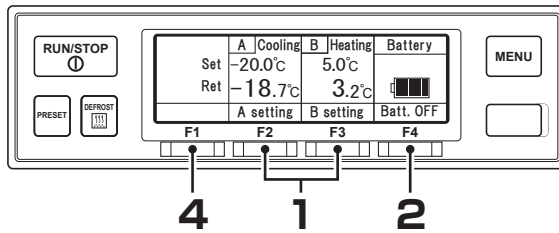

## Suspending (sleep) the compartment operation (2-compartment model)

- 1** On the normal display screen (Right figure), press “F2 (Compartment A setting)” or “F3 (Compartment B setting)” switch to select the compartment of which operation is suspended.

	A Cooling	B Heating	Battery
Set	-20.0°C	5.0°C	
Ret	-18.7°C	3.2°C	
	A setting	B setting	Batt. OFF
F1	F2	F3	F4

- 2** Press “F4 (Sleep)” switch.

⇒ When the operation is suspended at the selected compartment (the screen of Step 3), press “F4 (Operate)” switch.

Set point			
-20.0°C			
Back	▲	▼	Sleep
F1	F2	F3	F4

- 3** “Sleep” is displayed.

⇒ If “F4 (Operate)” switch is pressed, the display of “Sleep” extinguishes. (the screen of Step 2)

Set point			
-20.0°C			Sleep
Back			Operate
F1	F2	F3	F4

- 4** Press “F1 (Back)” switch.

⇒ Operation/Suspension is completed at the selected compartment, and the display returns to the normal display screen.

	A Sleep	B Heating	Battery
Set		5.0°C	
Ret		3.2°C	
	A setting	B setting	Batt. OFF
F1	F2	F3	F4

### NOTE

- It is impossible to suspend operation at all compartments.

## Setting the temperature

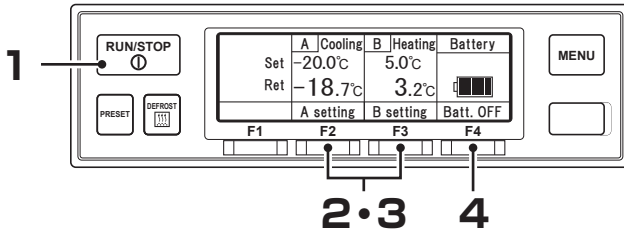

**1** Start the operation of refrigeration unit. (☞ Page 41)

**2** On the normal display screen (Right figure), press “F2 (A setting)” or “F3 (B setting)” switch.

	A Cooling	B Heating	Battery
Set	-20.0°C	5.0°C	
Ret	-18.7°C	3.2°C	
	A setting	B setting	Batt. OFF
F1	F2	F3	F4

**3** Press “F2 (▲)” or “F3 (▼)” switch, and set a temperature.

Set point			
-20.0°C			
Back	▲	▼	Sleep
F1	F2	F3	F4

**NOTE**

- Each push on “F2” switch increases the value by 0.5 while the value decreases by 0.5 at each push on “F3” switch. If the switch is held down, the value changes continuously.

**4** Press “F4 (Set)” switch.

⇒ The setting completes, and the display returns to the normal display screen.

Set point			
-15.5°C			
Back	▲	▼	Set
F1	F2	F3	F4

**NOTE**

- The “Preset” function is provided, with which it can be selected from 4 setting temperatures which you have registered in advance. (☞ Pages 45 to 47)

## Setting the preset defrost interval and set point

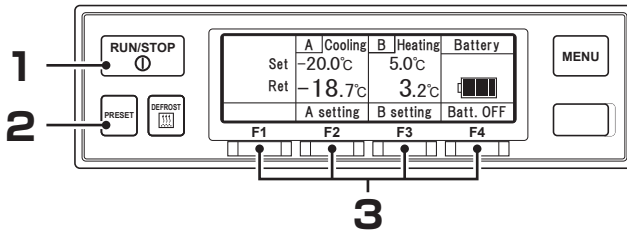

**1** Start the refrigeration unit. (☞ Page 41)

**2** Press the “PRESET” switch.

⇒ The display changes to the preset setting screen. Right figure shows the setting values at the shipping from factory.

**[1-compartment model]**

Def 6.0Hr	Def 6.0Hr	Def 6.0Hr	Def 6.0Hr
Set temp. -18.0°C	Set temp. -5.0°C	Set temp. 5.0°C	Set temp. 20.0°C
F1	F2	F3	F4

**[2-compartment model]**

Def 6.0Hr	Def 6.0Hr	Def 6.0Hr	Def 6.0Hr
A: 0.0°C	A: 0.0°C	A: 0.0°C	A: 0.0°C
B: 0.0°C	B: 0.0°C	B: 0.0°C	B: 0.0°C
F1	F2	F3	F4

**3** Press “F1 (~ F4)” switch.

⇒ Desired preset operation pattern, defrost interval and temperature are set, and the display returns to the normal display screen.

## 5 Operation

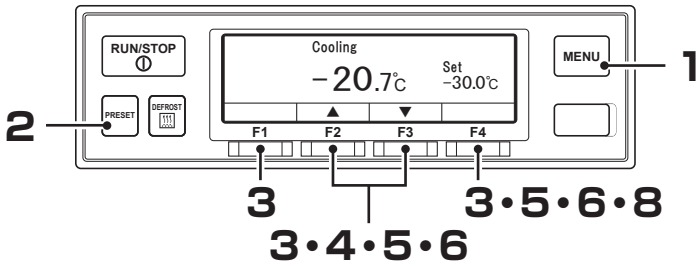

### Changing the registered preset defrost interval and set point

**1** Press the “MENU” switch when the refrigeration unit is stopped.

⇒ The cabin controller becomes activated and the display changes to the “Normal display screen”.

**2** Press the “PRESET” switch.

**[2-compartment model]**  
Set temp. of Zone A and B are displayed.

Def	6.0Hr
A:	-25.0°C
B:	-5.0°C

F1

Def 6.0Hr	Def 6.0Hr	Def 6.0Hr	Def 6.0Hr	Def 6.0Hr
Set temp. -18.0°C	Set temp. -5.0°C	Set temp. 5.0°C	Set temp. 20.0°C	

F1

F2

F3

F4

**3** Hold down “F1 (~ F4)” switch for 3 seconds.

⇒ Registered preset of “Defrost interval timer” is displayed.

Defrost interval timer setting			
6.0Hr			
Back	▲	▼	Next

F1

F2

F3

F4

**4** Press “F2 (▲)” or “F3 (▼)” switch to select a setting time.

Defrost interval timer setting			
5.0Hr			
Back	▲	▼	Next

F1

F2

F3

F4

#### NOTE

- The defrosting can be set at OFF, or at every 0.5 hours in the range of from 0.5 hours to 12 hours.

## 5 Press “F4 (Next)” switch.

⇒ Registered preset of “Set point” is displayed.

Set point			
20.0°C			
Back	▲	▼	Set
F1	F2	F3	F4

### [2-compartment model]

Set point of Zone A is displayed. Also, press “F2” or “F3” switch to select Operate / Sleep for each zone.

#### “F2 (Change)” or “F2 (Operate)” switch

⇒ Step 6

#### “F3 (Sleep)” switch

⇒ Press “F4 (Next)” switch to Step 7

#### “F4 (Next)” switch

⇒ Step 7

Set point (Zone A)			
-30.0°C			
Back	Change	Sleep	Next
[Operate]	▲ F2	▼ F3	[Sleep]

Set point (Zone A)			
			Sleep
Back	Operate		Next
F1	F2	F3	F4

## 6 Press “F2 (▲)” or “F3 (▼)” switch, and set a temperature.

### [1-compartment model]

⇒ Step 8

### [2-compartment model]

After setting Zone A

#### “F4 (Next)” switch

⇒ Step 7

Set point			
20.0°C			
Back	▲	▼	Set
F1	F2	F3	F4

Set point (Zone A)			
-30.0°C			
Back	▲	▲	Next
F1	F2	F3	F4

### NOTE

- Each push on “F2” switch increases the value by 0.5 while the value decreases by 0.5 at each push on “F3” switch. If the switch is held down, the value changes continuously.

## 7 [2-compartment model]

Set point of Zone B is displayed. Set in the same way as Zone A.

Set point (Zone B)			
20.0°C			
Back	Change	Sleep	Set
F1	F2	F3	F4

## 8 Press “F4 (Set)” switch.

⇒ The setting completes, and the display returns to the normal display screen.

## Manual defrost operation

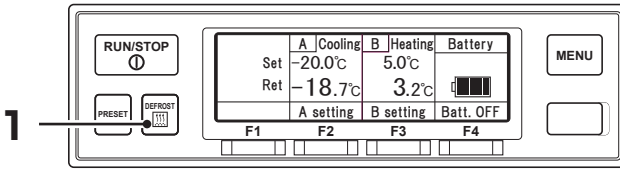

### Starting the manual defrost operation

1 Press the “DEFROST” switch once during cooling operation.

⇒ The defrost operation starts.

#### NOTE

- The defrost operation may not start when the inside container temperature is higher.

### Ending the manual defrost operation

If the defrost operation completes, it returns to the cooling operation.

If it is necessary to interrupt the defrost operation and to return to the cooling operation, press the “DEFROST” switch once more.

If the “RUN/STOP” switch is turned “OFF”, it interrupts the defrost operation and stops the operation of refrigeration unit.

#### NOTE

- The manual defrost operation can be made also during the thermostat OFF stop.
- The manual defrost operation cannot be made during the operation stop and the heating operation.

## Setting the ON timer

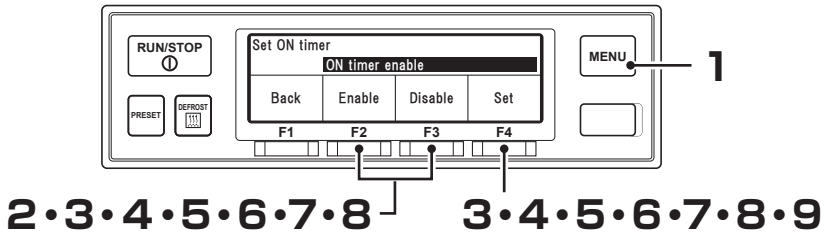

### 1 Press "MENU" switch.

⇒ The display changes to "Main menu" screen.

### 2 Press "F2 (▲)" or "F3 (▼)" switch till the display changes to "Sub-menu" screen (Right figure).

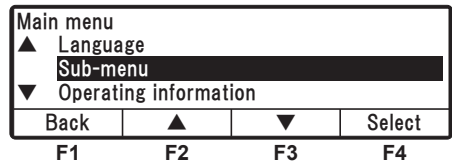

### 3 Press "F4 (Select)" switch to change to "Sub-menu" screen. Press "F2 (▲)" or "F3 (▼)" switch till the display changes to "Set ON Timer" screen (Right figure).

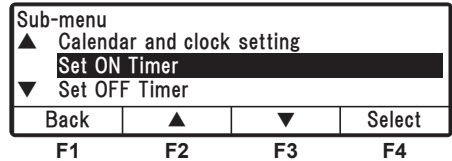

### 4 Press "F4 (Select)" switch to change to "ON timer enable" mode (Right figure).

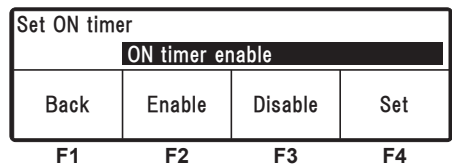

⇒ If Enable is selected by pressing "F2 (Enable)" switch, go to Step 5.

⇒ When Disable has been selected by pressing "F3 (Disable)" switch, if "F4 (Set)" switch is pressed, the display returns to the screen of Step 3.

### 5 Press "F4 (Set)" switch.

⇒ Press "F2 (▲)" or "F3 (▼)" switch, and set the time (Date) of Set ON timer.

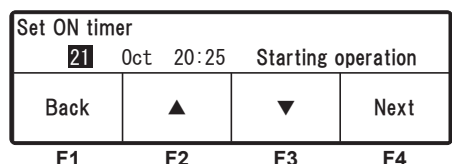

## 5 Operation

### 6 Press “F4 (Next)” switch.

⇒ Press “F2 (▲)” or “F3 (▼)” switch, and set the time (Month) of Set ON timer.

Set ON timer			
22	Oct	20:25	Starting operation
Back	▲	▼	Next
F1	F2	F3	F4

### 7 Press “F4 (Next)” switch.

⇒ Press “F2 (▲)” or “F3 (▼)” switch, and adjust the time (Hour) of Set ON timer.

Set ON timer			
22	Oct	23:25	Starting operation
Back	▲	▼	Next
F1	F2	F3	F4



#### NOTE

- Time is displayed in the 24-hour scale. If it is “7 PM”, set as “19:00”.

### 8 Press “F4 (Next)” switch.

⇒ Press “F2 (▲)” or “F3 (▼)” switch, and adjust the time (Minute) of Set ON timer.

Set ON timer			
22	Oct	23:30	Starting operation
Back	▲	▼	Set
F1	F2	F3	F4

### 9 Press “F4 (Set)” switch.

⇒ The setting completes, and the display returns to the screen of Step 3, “Sub-menu”.



#### NOTE

- When operating the unit with the ON timer using commercial power supply, confirm that the commercial power supply is connected to the refrigeration unit.
- Take note that the refrigeration unit starts the operation automatically at the setting time when the ON timer is set.



## Setting the OFF timer

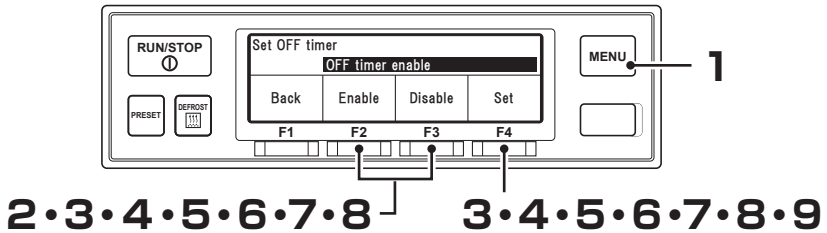

### 1 Press "MENU" switch.

⇒ The display changes to "Main menu" screen.

### 2 Press "F2 (▲)" or "F3 (▼)" switch till the display changes to "Sub-menu" screen (Right figure).

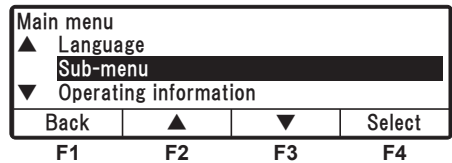

### 3 Press "F4 (Select)" switch to change to "Sub-menu" screen. Press "F2 (▲)" or "F3 (▼)" switch till the display changes to "Set OFF Timer" screen (Right figure).

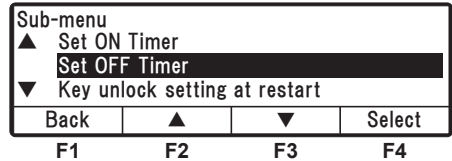

### 4 Press "F4 (Select)" switch to change to "OFF timer enable" mode (Right figure).

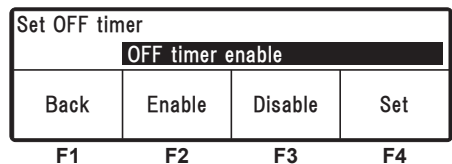

⇒ If Enable is selected by pressing "F2 (Enable)" switch, go to Step 5.

⇒ When Disable has been selected by pressing "F3 (Disable)" switch, if "F4 (Set)" switch is pressed, the display returns to the screen of Step 3.

### 5 Press "F4 (Set)" switch.

⇒ Press "F2 (▲)" or "F3 (▼)" switch, and set the time (Date) of Set OFF timer.

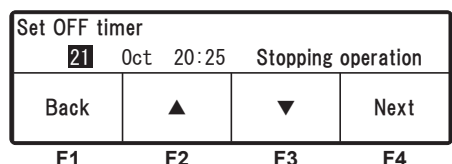

## 5 Operation

### 6 Press “F4 (Next)” switch.

⇒ Press “F2 (▲)” or “F3 (▼)” switch, and set the time (Month) of Set OFF timer.

Set OFF timer			
22	Oct	20:25	Stopping operation
Back	▲	▼	Next
F1	F2	F3	F4

### 7 Press “F4 (Next)” switch.

⇒ Press “F2 (▲)” or “F3 (▼)” switch, and adjust the time (Hour) of Set OFF timer.

Set OFF timer			
22	Oct	23:25	Stopping operation
Back	▲	▼	Next
F1	F2	F3	F4

#### NOTE

- Time is displayed in the 24-hpur scale. If it is “7 PM”, set as “19:00”.

### 8 Press “F4 (Next)” switch.

⇒ Press “F2 (▲)” or “F3 (▼)” switch, and adjust the time (Minute) of Set OFF timer.

Set OFF timer			
22	Oct	23:30	Stopping operation
Back	▲	▼	Set
F1	F2	F3	F4

### 9 Press “F4 (Set)” switch.

⇒ The setting completes, and the display returns to the screen of Step 3, “Sub-menu”.

#### NOTE

- Take note that the refrigeration unit stops the operation automatically at the setting time when the OFF timer is set.

## Setting the key lock/unlock

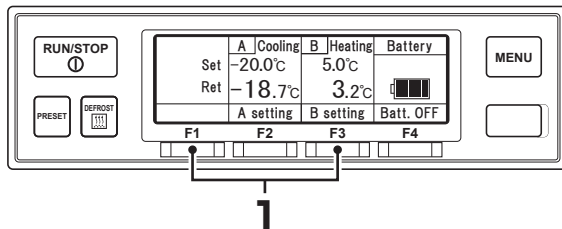

### NOTE

- Key lock setting disables switch operation except for the "RUN/STOP" switch.

## Setting the key lock

- 1 Hold down "F1" and "F3" switch for 3 seconds during the refrigeration unit operation or "Normal display screen".

⇒ The setting completes, and the key mark is displayed (Upper right figure, call "key lock screen").

	A	Cooling	B	Heating	Battery
Set	-20.0°C		5.0°C		
Ret	-18.7°C		3.2°C		
On					

Key lock screen

⇒ If you press any switch other than "RUN/STOP" switch while the key is locked, the "key operation locked" is displayed (Lower right figure).

Key operation locked					
On					

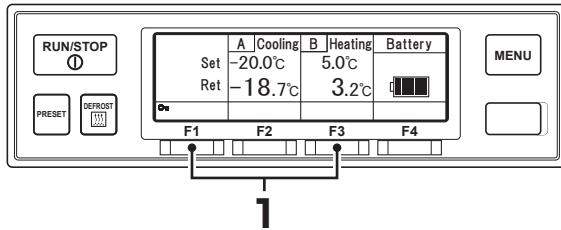

 **NOTE**

- This section describes when “key unlock setting at restart” is OFF.
- If “key unlock setting at restart” is ON, the key lock is released when the refrigeration unit stops. (→ page 28)

---

## Setting the key unlock

**1** Hold down “F1” and “F3” switch for 3 seconds during the refrigeration unit operation or “key lock screen”.

⇒ The setting completes, and the display returns to the normal display screen.

# 6 Loading

## Preparation before loading

### CAUTION



Before loading, cool down or heat up inside of the container to the appropriate setting temperature for the transportation of cargoes. Cargoes must be cooled down or heated up to the designated temperature with other refrigeration device in advance.

- Otherwise, it may cause damages of the cargoes or deterioration of the quality. Or it may cause emergency stop of the refrigeration unit.

---

When entering the container during loading or unloading of cargoes, be sure to stop the refrigeration unit.

---

When entering the cabinet during loading or unloading of cargoes, be sure to wear appropriate clothing or protective gear suitable for the temperature.

---

Do not load the volatile or inflammable substances in the container.

---

- 1 Cargoes must be cooled down or heated up to the designated temperature with other refrigeration device in advance.
- 2 Clean inside of the container.
- 3 Perform the inspection of the refrigeration unit and the body\*.  
(👉 Refer to page 58)  
\* Check with the body manufacturer for the items to be inspected.
- 4 Set the right temperature for transportation of the cargo and cool down or heat up inside of the container to the setting temperature.  
(👉 Refer to page 44)

### NOTE

- The temperature inside of the closed container may reach 60°C under a blazing sun. Loading in such a container causes damages or deterioration of the quality. Be sure to cool down inside of the container to the setting temperature before loading.
- When it is hardly cooled down, contact your nearest dealer before loading.

# Loading and unloading

## Loading procedure

**1** Stop the cooling operation. (☞ Refer to page 42)

**2** Load the cargoes in the container.

Leave a space between the cargo and inner wall of the container as shown in the following figure in order to circulate cool air.

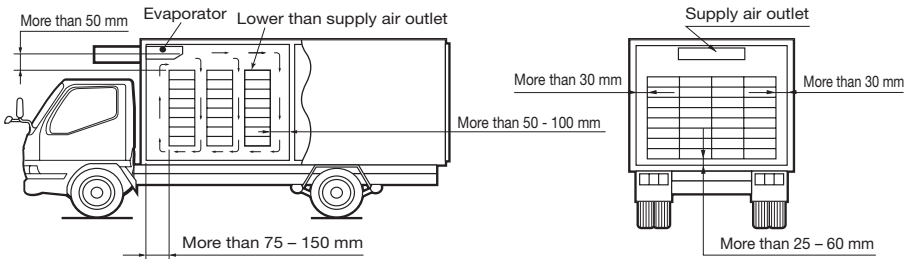

**3** Keep the top layer of the cargo as flat as possible.

### **CAUTION**



**Waterproof the cargoes if they need to be.**

- Water may drip or splash from the evaporator unit.

**When stacking cargoes, secure safety.**

**When loading fragile cargoes, use appropriate protective materials.**

- It could damage cargoes or cause injury or accident.

**4** When transporting any cargo to be protected from water damage, cover the cargo placed under the evaporator unit or near its outlet with waterproof sheet.

**5** After completing loading, start the operation of the refrigeration unit. (☞ Refer to page 41)

---

## Unloading

**1** Stop the cooling operation. (☞ Refer to page 42)

**2** Unload the cargoes.

---

 **NOTE**

- Frost forms and accumulates on the evaporator coil while the refrigeration unit is operated during loading or unloading.
  - Since the inside container temperature rises (or falls during cold winter) while the door is kept opened, load or unload as quickly as possible.
  - A curtain helps to prevent ambient air from entering or inside air from escaping during loading or unloading.
  - Do not load the volatile or inflammable substances in the container.
-

# 7 Inspection

## Precautions for inspection

Always carry out the following inspections before the operation to prevent any damages of the refrigeration unit before happening.

### **WARNING**



**Do not perform the inspection in the place where the combustible gas leakage may happen.**

- Otherwise, if the gas might leak out, it stays around the refrigeration unit and may catch a fire.



**Be sure to perform daily and periodic inspections.**

- Otherwise, it may cause troubles of the refrigeration unit or accidents.

**The area must be well ventilated when performing the inspection indoors.**

- Otherwise, it may cause oxygen deficiency due to the exhaust gas.

### **CAUTION**



**Use 1-phase AC230V 50Hz for power supply.**

- It may cause damage of the refrigeration unit or a fire if any other power supply is used.

**Sufficient care must be taken for foothold when evaporator inspection working at a higher place on a stepladder.**

- If you step off, you may fall down and get injured.

**When leakage of the refrigerant is detected, contact your nearest dealer immediately.**

- Otherwise, it may cause blindness or frostbite.



 **CAUTION**

**Do not start maintenance without more than 5 minutes after stopping operation.**

- Refrigerant pipes are dangerously hot. There is risk of burn if touched carelessly.



**Before performing the inspection or cleaning work, stop the refrigeration unit using the RUN/STOP switch, vehicle switch key off and disconnect the battery terminals and the plug of the power cord.**

**After that, when 5 min. or longer elapse, start the inspection or cleaning work.**

- Otherwise, it may cause injury or an electric shock due to unexpected start.



**Apply the parking brake and put chocks under wheels during inspection.**

- If the vehicle moves, it could cause injury or accident.

**When working on the fan motor, make sure to disconnect the fan motor connector before hand.**

---

## Daily inspection

Before using the refrigeration unit, the customer should perform the daily inspection.

---

### Inspection of condenser coil

- 1 Check the coil for fouling with dust.
  
- 2 When the coil is fouled, wash it with a soft brush and water.



#### NOTE

- Dirty coil could deteriorate the refrigeration capacity or cause malfunction of protective devices, which may disable the operation of refrigeration unit. Clean the coil at regular intervals.
  - In case of the nose mount type condenser, you need to work at a higher place. Work with sufficient care or consult the nearest dealer.
-

---

## Periodic inspection

Please ask your nearest dealer to perform periodic inspection to ensure to use the refrigeration unit in the best condition all the time.

Periodic inspection consists of the following items.

1. Inspection at commissioning
2. Monthly inspection
3. Inspection at every 6 months

Check the contents of inspection with the check sheet submitted after the periodic inspection.

# Periodic inspection check sheet

Customer							Customer's signature		
Inspection interval					Serial No.	Body manufacturer	Delivery date		
			Condensing unit				Inspection date		
			Evaporator unit A						
			Evaporator unit B						
Every six months	Every one month	Installation test run	Vehicle	Model		Refrigeration unit installation company	Inspection company		
				Serial No.			Inspector		
Inspection items							Inspection result	Remarks	
<input type="radio"/>		<input type="radio"/>	Inspection for seal sections of body where refrigeration unit pass through						
<input type="radio"/>		<input type="radio"/>	Inspection for adequacy of piping clamps						
<input type="radio"/>		<input type="radio"/>	Inspection for secure drain hose connections and adequacy of clamps						
<input type="radio"/>	<input type="radio"/>	<input type="radio"/>	Inspection for belt slack, parallelism (alignment), and damage						
<input type="radio"/>	<input type="radio"/>	<input type="radio"/>	Inspection for contact with other parts (alternator, piping, wiring)						
<input type="radio"/>		<input type="radio"/>	Tightening of installation bolts (refrigeration unit, compressor, alternator, bracket, fan & motor, fan, cover of refrigeration unit and battery box)						
		<input type="radio"/>	Inspection for incorrect wiring and for adequacy of clamps						
<input type="radio"/>		<input type="radio"/>	Inspection for electrical wiring terminal looseness, damage on wiring and sheath (* Particularly, high-voltage cable and ground cable), Retighten the wiring grip of the control box.						
<input type="radio"/>			Inspection of relay contact						
<input type="radio"/>	<input type="radio"/>		Cleaning of refrigeration unit (condenser fan outlet), drain discharge ports and radiator fin (back of control box)						
<input type="radio"/>		<input type="radio"/>	Inspection for refrigerant system gas leaks (oil leaks)						
<input type="radio"/>		<input type="radio"/>	Inspection for abnormal noise and abnormal vibration (compressor, alternator, fan & motor, piping)						
<input type="radio"/>		<input type="radio"/>	Confirmation of compressor, condenser fan and evaporator fan start/stop with thermostat						
<input type="radio"/>	<input type="radio"/>	<input type="radio"/>	Cooling inspection (indication of LCD display temperature, high/low pressure inspection)						
<input type="radio"/>		<input type="radio"/>	Confirmation of defrosting operation						
<input type="radio"/>		<input type="radio"/>	Confirmation of high pressure switch operation						
Daily inspection			Operation check						
Seasonal inspection			Cleaning of condenser coil, entire refrigeration unit						

## Refrigerant and refrigerating machine oil

	Kind/Brand
Refrigerant	R452A
Refrigerating machine oil	Idemitsu Kosan Co., Ltd. DAPHNE HERMETIC OIL FV685

## Power supply system

(50Hz)

Specification of power supply					
Capacity of power supply (kVA)	Switch		Voltage fluctuation	Voltage drop at start-up	Interphase imbalance
	Molded-case circuit breaker				
	Capacity of switch (A)	Rated capacity of over-current breaker (A)			
10	30	30	Within 10% of rated voltage	Within 15% of rated voltage	Within 3%

## WARNING



**Be sure to perform the grounding work (PEN) for the electric equipment that supplies the power to the refrigeration unit.**

- If the grounding work is not performed correctly, this may cause a fire.

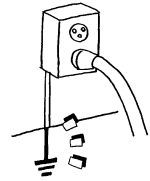

**Be sure to perform the electrical construct work in accordance with IEC 60364 and use the dedicated circuits and overcurrent circuit breakers.**

- It may cause an electric shock or a fire if there is capacity shortage of electric circuit.

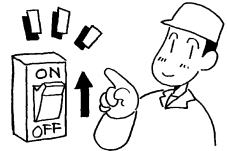

## CAUTION



**Use 1-phase AC230V 50Hz for power supply.**

- It may cause damage of the refrigeration unit or a fire if any other power supply is used.

## Climate class

The climate class of this refrigeration unit is as follows.

- Climate class 4 (ambient of  $32\pm 2^{\circ}\text{C}$  with 55%RH)

## 8 Cautions for use

**When operating at a low inside container temperature for a long period of time:**

If the refrigeration unit is operated for a long period time with the inside container temperature below 10°C, ice will grow on the inside refrigeration unit, etc. Stop the operation of refrigeration unit once or twice every week and open up the door on the vehicle body to return the inside of container to ordinary temperature and melt grown ice.

### **CAUTION**



**Park the vehicle at a flat place and operate the refrigeration unit.**

- Otherwise, the evaporator becomes unable to drain and water overflows in the container, damaging cargoes with water.



**When stopping the refrigeration unit for a long period of time:**

To prevent troubles by stopping for prolonged time, operate the refrigeration unit for 15 minutes once every 3 to 4 days.

# 9 For emergency

## Alarm display

- If any error occurs, the abnormal display  lights or blinks on the LCD (the backlight lights or blinks).
- Check the alarm code displayed at the right-hand side of the abnormal display. (If it is a light error, the alarm content at the right-hand side of the alarm code is not displayed.)

Abnormal display			
Alarm code		Alarm content	
 E010	HP Abnormally high		
Set	-20.0°C	5.0°C	
Ret	-18.7°C	3.2°C	
	A setting	B setting	Batt. OFF

When no error code is displayed at the LCD, change to the alarm display as described below, and check the alarm content.

## Switching "Normal display" and "Alarm display"

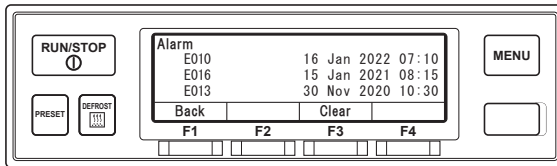

### Switching from "Normal display screen" to "Alarm display mode"

Press once each on the [MENU] switch, [F3(▼)] switch and [F4(Select)] switch. (The display returns to the "Normal display screen" 20 seconds later.)

### Switching from "Alarm display mode" to "Normal display screen"

Press the [F1(Back)] switch 2 times on the extended display of "Alarm display mode". (The screen changes to "Normal display screen" in 20 seconds in case of 1 press.) or hold down [MENU] switch.

## Countermeasures

Refer to "List of alarm codes" for the contents of each alarm code and its countermeasure. (☞ Refer to pages 67 to 68)

### CAUTION



**Surely follow the instructions of this operation manual for the countermeasures of the troubles.**

- Otherwise, it may cause injury or an electric shock due to unexpected start.

## When you contact your nearest dealer

When you contact your nearest dealer for the trouble occurred during operation of the refrigeration unit, give them the following information.

- |                                   |   |
|-----------------------------------|---|
| ● Company name                    | ● Kind of cargo                                 |
| ● Customer's name                 | ● Setting temperature                           |
| ● Company telephone number        | ● Present inside container temperature          |
| ● Number of the plate             | ● Specific condition of trouble                 |
| ● Type of the refrigeration unit  | ● Alarm code displayed in the LCD display area. |
| ● Present location of the vehicle |   |
| ● Destination                     |   |

## Resuming operation after an emergency stop

### Resuming operation after an emergency stop

- Press the [RUN/STOP] switch on the cabin controller to stop the unit. (Confirm that the LCD display is turned off.)
- Press the [RUN/STOP] switch once more to resume the operation of the unit.

### CAUTION



**If the unit stops by the same trouble immediately after the operation is resumed, stop the operation and contact your nearest dealer.**

- Otherwise, it may cause serious damages or accidents.



## List of alarm codes

Alarm Code	Trouble	Countermeasures	Alarm Lamp	Unit Condition
E001	Evaporator fan motor fuse break (Zone X)	Evaporator fan motor fuse in the compartment A (F11) or compartment B (F12) has blown. Ask a dealer for inspection.	On	Unit stops.
E002	Condenser fan motor fuse break	Condenser fan motor fuse (F21) has blown. Ask a dealer for inspection.	On	Unit stops.
E006	Load drive circuit fuse has break	Fuse (F2) has blown. Ask a dealer for inspection.	On	Unit stops.
E009	Commercial power supply defective	The commercial power supply cannot be detected. Inspect the power supply.	Blinking	Unit stops. (Automatic operation resume)
E010	HP abnormally high	High-pressure switch has tripped. 1) Check that the condenser fan operates. If the condenser fan does not operate, ask a dealer for inspection. 2) Inspect if condenser coil is too dirty. If so, clean up with water.	On	Unit stops.
E013	Td abnormally high	A failure occurs since the refrigerant temperature on the discharge side of the compressor reaches the protection temperature. Ask a dealer for inspection.	On	Unit stops.
E014	Refrigerant shortage	Refrigerant quantity is insufficient. Ask a dealer for inspection.	On	Unit stops.
E016	LPT failure	The low pressure sensor does not operate correctly. Ask a dealer for inspection.	On	Unit stops.
E017	HPT failure	The high pressure sensor does not operate correctly. Ask a dealer for inspection.	Blinking	Unit operation continues.
E032	Alternator generation not enough	The alternator generated voltage is low. Ask a dealer for inspection.	On	Unit stops.
E050	TH sensor failure (Zone X)	Short-circuit on the inside container temperature sensor. Ask a dealer for inspection.	On	Unit stops.
E060	HPS failure	High pressure switch has failed. Ask a dealer for inspection.	Blinking	Unit stops. (Automatic operation resume)
E063	Td sensor failure	Discharge gas temperature sensor disconnected or shorted. Ask a dealer for inspection.	On	Unit stops.
E099	Controller communication failure	Cabin controller cannot communicate properly. Ask a dealer for inspection.	On	Unit stops.
E102	Condenser fan motor fuse break	One of the condenser fan motors (F21, F22) blows. Ask a dealer for inspection.	Blinking	Unit operation continues.
E103	Inverter board fuse break	The fuse on the inverter board (F3) blows. Ask a dealer for inspection.	On	Unit stops.
E104	Drain hose heater fuse break (Zone X)	The drain hose heater fuse of the compartment A (F31) or compartment B (F3) has blown. Ask a dealer for inspection.	On	Unit stops.
E250	EVT sensor failure (Zone X)	Broken wire or short-circuit on the evaporator outlet temperature sensor. Ask a dealer for inspection.	On	Unit stops.

## 9 For emergency

Alarm Code	Trouble	Countermeasures	Alarm Lamp	Unit Condition
E252	THD sensor failure (Zone X)	Supply air temperature sensor A or B is disconnected or shorted. Ask a dealer for inspection.	Blinking	Unit operation continues.
E256	ATS sensor failure	Ambient air temperature sensor is disconnected or shorted. Ask a dealer for inspection.	Blinking	Unit operation continues.
E280	Battery voltage low	Battery voltage has dropped. Replace the battery if aged.	On or blinking	Unit stops. (Operation continues partially.)
E301	Inverter overheat	The inverter overheat failure occurs. Ask a dealer for inspection.	On	Unit stops.
E302	Inverter overcurrent	The inverter overheat failure, compressor rotation control failure, or phase failure in the compressor circuit occurs. Ask a dealer for inspection.	On	Unit stops.
E303	Inverter voltage high	A high-voltage failure occurs in the commercial power supply. Ask a dealer for inspection.	On	Unit stops.
E304	Inverter voltage low	A low voltage failure occurs in the commercial power supply. Ask a dealer for inspection.	On	Unit stops.
E601	Intelligent power module failure	A failure occurs in the inverter IPM. Ask a dealer for inspection.	On	Unit stops.
E602	FTH failure	The heat sink temperature sensor of the inverter has a broken wire or is short-circuited. Ask a dealer for inspection.	On	Unit stops.
E608	Current sensor failure	The current sensor has a broken wire or is short-circuited. Ask a dealer for inspection.	On	Unit stops.
E616	Step-down DC-DC converter failure	The step-down DC-DC converter malfunctions (output stop), a low voltage failure occurs in the vehicle power system, or a failure occurs in the communication with the vehicle power system. Ask a dealer for inspection.	On	Unit stops.
E991	Communication failure (Main-Comm)	Since the communication between the main board and communication board cannot be performed correctly. Ask a dealer for inspection.	On	Unit stops.
E992	Communication failure (Comm-INV)	Since the communication between the main board and inverter board cannot be performed correctly. Ask a dealer for inspection.	On	Unit stops.
E930	Power supply system failure	The power supply system failure occurs. Ask a dealer for inspection.	On	Unit stops.





---

**MITSUBISHI HEAVY INDUSTRIES THERMAL SYSTEMS, LTD.**

TRANSPORTATION REFRIGERATION DEPARTMENT

3-1, ASAHI, NISHIBIWAJIMA-CHO, KIYOSU, AICHI, 452-8561, JAPAN

Phone : +81-52-503-9312

**MITSUBISHI HEAVY INDUSTRIES THERMAL TRANSPORT EUROPE GmbH**

HANNOVERSCHE STRASSE 49 49084 OSNABRÜCK, GERMANY

Phone : +49(0) 541 80005

URL : <https://mhi-tte.com>