

# OPERATION MANUAL

## MITSUBISHI TRANSPORT REFRIGERATION UNIT TDJS Series

This operation manual is intended to provide users with a good knowledge to use Mitsubishi Refrigeration Unit safely.

Operate or service the refrigeration unit only after you have read this manual and understand its contents.

Carefully store this manual in a fixed place so that it is immediately available for your reference when you need it.

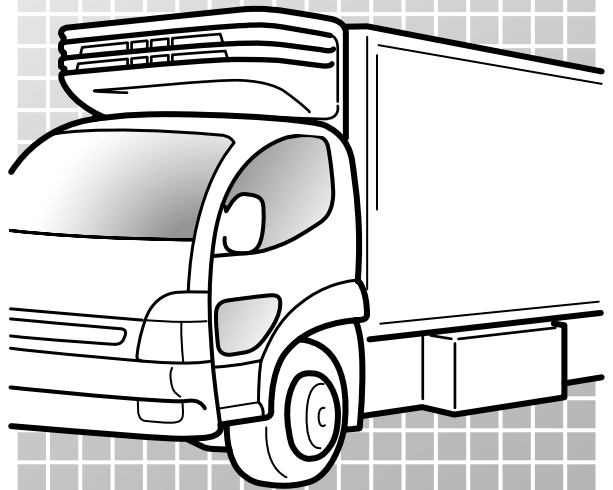

Original Instructions



TSJ012A222   
YEAR:2022

# Thank you for your purchase of Mitsubishi Transport Refrigeration Unit.

---

## Purpose of use and application

This Refrigeration Unit is intended to carry the cargo (with the exception of volatile, inflammable, hazardous and corrosive matters) on a transportation vehicle, keeping the inside container temperature at a certain degree.

If the Refrigeration Unit is used for any purposes other than this purpose, it may cause accidents or damages.

---

## Important information

For questions or information, contact your nearest dealer.

- Be sure to follow the contents described in this manual in order to protect yourself and other people from potential risks of this refrigeration unit and to prevent it from getting damaged.
- We are not able to foresee all potential risks of this refrigeration unit or dangers due to mishandling by the customers. Therefore, it is necessary to take measures for safety in addition to the items described in this manual or on warning labels.
- For the following works, contact your nearest dealer. If those works were carried out by customer, the refrigeration unit may lose its performance and we may not be able to ensure the safety of the customer.
  - (a) Installation, modification, specification change and disposal of the refrigeration unit
  - (b) Maintenance of electric appliances
  - (c) Abnormal treatments which are not described in this manual
- This product contains fluorinated greenhouse gases.
  - Refrigerant:R404A(GWP(Global Warming Potential)=3922), R452A(GWP=2141)  
Refer to a label on unit about weight of fluorinated greenhouse gases and CO<sub>2</sub> equivalent. (  Refer to pages 4.)

---

## Operation manual

- This operation manual is prepared for people who speaks English. In case that person whose native language is not English handles this refrigeration unit, he or she must be instructed on safety by the customer. Furthermore, the warning labels described in their native language must be prepared and stuck on the proper places.
- This operation manual is copyrighted and all rights are reserved by our company. The drawings and technical information described in this manual may not, in whole or part, be published, copied, translated for the purposes other than above-mentioned and reduced to any electronic medium or machine-readable form without prior written consent with our company.
- This manual also contains the explanation of optional specification.
- The contents of this operation manual may differ from that of the refrigeration unit used by a customer due to specification change.
- The contents described in this operation manual may be changed without a prior notice.
- When transferring or lending the refrigeration unit, attach this operation manual together with the unit so that the operators should be able to have a good knowledge on safety.
- Keep this operation manual in the vehicle so that it is available for your reference when you need it.
- Unless otherwise noted, "right" and "left" directions are given as viewed from the front of the refrigeration unit.

---

## For disposal

Contact your nearest dealer when disposing the refrigeration unit. Observe the applicable laws and regulations in your country to dispose refrigerants and cooling water.

# Information on the Models

This operation manual describes how to use the following models.

## (1) Standard system for single refrigeration compartment

- Integral type TDJS35\*E / TDJS50\*E / TDJS70\*ZE

## (2) 2-evaporator system for two refrigeration compartments

- Integral type TDJS35\*E-M / TDJS50\*E-M / TDJS70\*E-M

## (3) Model Information

Unit Model		System	Unit Weight: kg	
Refrigeration unit	TDJS35*E-L#	Standard	74	
	TDJS50*E-L#		84	
	TDJS70*E-L#		107	
Refrigeration unit	TDJS35*E-L#M	2-evaporator	72	
	TDJS50*E-L#M		81	
	TDJS70*E-L#M		102	
	Evaporator unit		TDS25EX*#-L	20
			TDS40EX*#-L	25
			TDS50EX*#-L	30

\* : Indicates destination or type of refrigerant.

# : Indicates electrical system rated voltage difference.(1= DC12V, 2= DC24V)

# Contents

Purpose of use and application- I	Reinstallation of refrigeration unit ----- 16
Important information ----- I	Modification of refrigeration unit and specification change ----- 16
Operation manual -----II	Emergency measures ----- 17
For disposal -----II	Handling of warning labels ---- 19
Information on the models ----- III	Prevention of start during inspection work----- 21
Contents----- IV	Clothing and protective equipment----- 21
<b>1 Function of Refrigeration Unit----- 1</b>	When abnormal conditions are detected ----- 21
<b>2 Name of each part ----- 2</b>	For emergency----- 21
Arrangement plan for main parts -----2	<b>4 Initial setting ----- 22</b>
Refrigeration unit (Integral type) -----4	Display and function of main menu ----- 22
Rear evaporator unit (2-compartment model) ----- 5	Language setting mode ----- 23
Compressor -----6	Display and function of Sub-menu ----- 24
Control box -----6	Setting the calendar and clock (Date, Month, Year) ----- 26
Cabin controller -----7	Displaying the maintenance information ----- 28
Digital display area-----8	Setting the defrost interval ---- 29
Protective devices ----- 10	Setting LCD backlight ----- 30
<b>3 Precaution for safety ---- 11</b>	<b>5 Operation----- 32</b>
Signs on safety ----- 11	Starting the operation----- 33
Precautions ----- 12	Stopping the operation ----- 33
General precautions ----- 12	Suspending (sleep) the compartment operation (2-compartment model) ----- 34
During and after the operation ---- 13	
Inspection/Cleaning/Repair ----- 14	
Loading ----- 15	
Handling of electric equipment and power codes ----- 16	

Setting the temperature -----	35		
Setting the preset temperature---	36		
Manual defrost operation-----	37		
Starting the manual defrost operation -----	37		
Ending the manual defrost operation -----	37		
Setting the ON timer -----	38		
Setting the OFF timer -----	40		
<b>6 Loading -----</b>	<b>42</b>		
Preparation before loading ----	42		
Loading and unloading -----	43		
Loading procedure -----	43		
Unloading -----	44		
<b>7 Inspection -----</b>	<b>45</b>		
Precautions for inspection ----	45		
Daily inspection-----	47		
Inspection of moving sections ----	47		
Inspection of condenser coil -----	47		
Periodic inspection-----	48		
Periodic inspection check sheet -----	49		
Refrigerant and refrigerating machine oil -----	50		
<b>8 Cautions for use -----</b>	<b>51</b>		
When operating at a low inside container temperature for a long period of time: -----	51		
When stopping the refrigeration unit for a long period of time: ----	51		
		<b>9 For emergency -----</b>	<b>52</b>
		Alarm display -----	52
		Switching "Normal display" and "Alarm display" -----	52
		Switching from "Normal display screen" to "Alarm display mode" -----	52
		Switching from "Alarm display mode" to "Normal display screen" -----	52
		Countermeasures -----	53
		Changing the fuse -----	53
		When you contact your nearest dealer -----	55
		Resuming operation after an emergency stop -----	55
		List of alarm codes-----	56

# 1 Function of Refrigeration Unit

This refrigeration unit has following functions.

## (1) Defrosting operation function

This is the function to protect evaporator from frosting during cooling operation and to prevent refrigerating power from decreasing.

There are following 2 methods to start defrosting operation.

### 1) Automatic defrosting operation

Defrosting starts automatically by the timer setting.

☞ Refer to page 29 for defrosting timer setting.

### 2) Manual defrosting operation

Defrosting starts forcibly by pressing the switch of controller.

☞ Refer to page 37 for how to operate.

As the defrosting operation is completed, the refrigeration unit returns to the cooling operation.

Defrosting operation will not start when the evaporator temperature is high even during the cooling operation

## (2) Timer operation function

This is the function to set starting time and stopping time of the operation .

☞ Refer to pages from 38 to 41 for how to set.

## 2 Name of each part

### Arrangement plan for main parts

■ Single compartment integral type

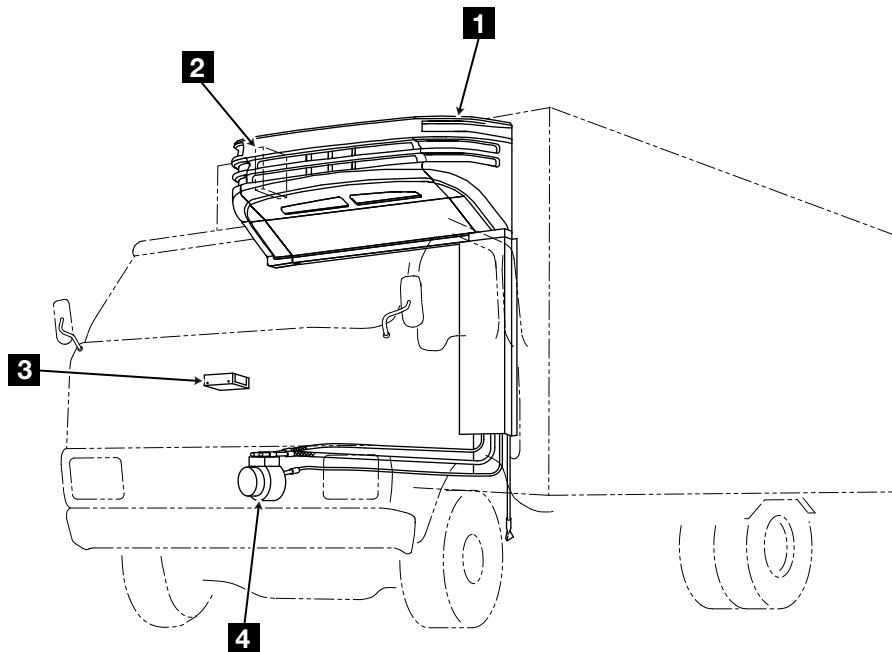

**1** Refrigeration unit

**3** Cabin controller

**2** Control box

**4** Compressor

· Actual locations of above units, etc. should be checked beforehand because they could vary depending on vehicle models, or other.



## ■ 2-compartment integral type

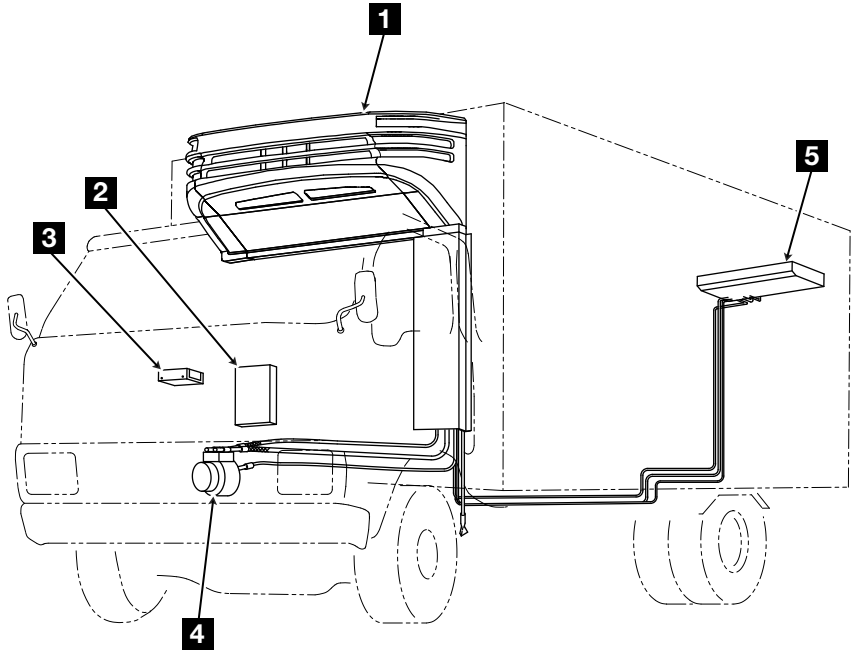

<b>1</b>	Refrigeration unit	<b>4</b>	Compressor
<b>2</b>	Control box	<b>5</b>	Rear evaporator unit
<b>3</b>	Cabin controller		

Actual locations of above units, etc. should be checked beforehand because they could vary depending on vehicle models, or other.

## Refrigeration unit (Integral type)

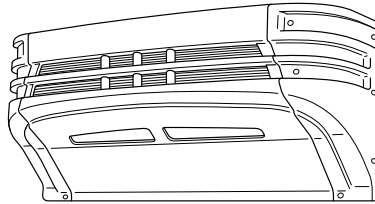

■ Top view

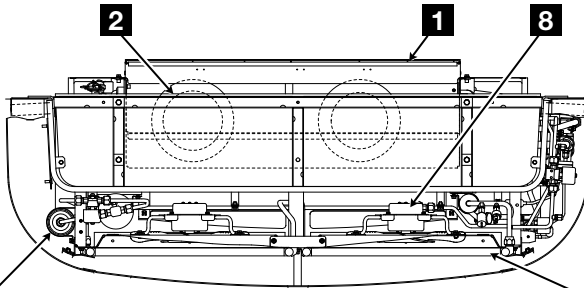

■ Front view

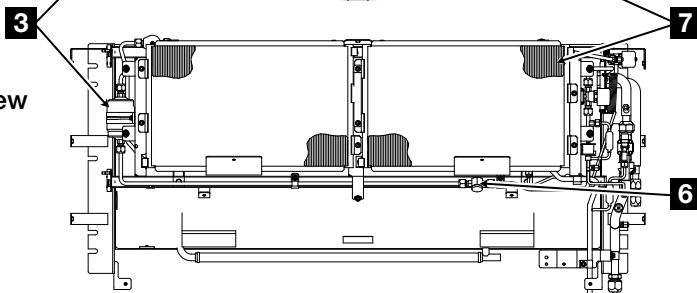

■ Rear view

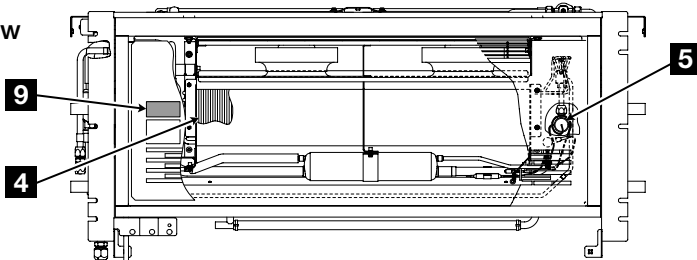

<b>1</b>	Evaporator outlet	<b>6</b>	Sight glass
<b>2</b>	Evaporator fan motor	<b>7</b>	Condenser coil
<b>3</b>	Dryer	<b>8</b>	Condenser fan motor
<b>4</b>	Evaporator coil	<b>9</b>	Label (F-Gas)
<b>5</b>	Expansion valve		

· Form of components and specifications may vary depending on models.

## Rear evaporator unit (2-compartment model)

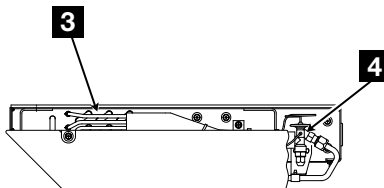
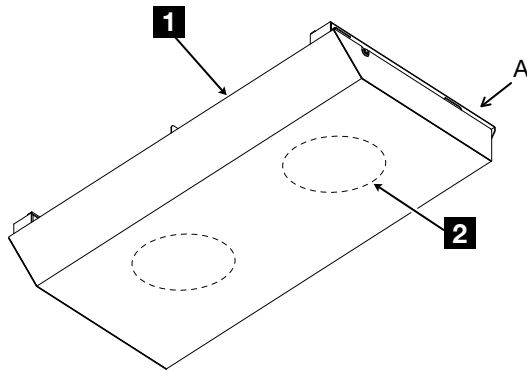

Inside of view "A"

**1** Evaporator outlet

**3** Evaporator coil

**2** Evaporator fan motor

**4** Expansion valve

· Form of components and specifications may vary depending on models.

---

# Compressor

■CS55

■CSA90, CSA150

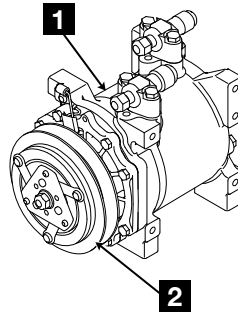
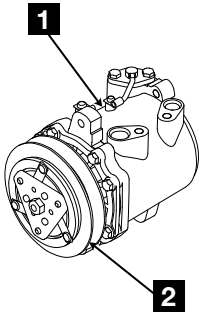

**1** Compressor

**2** Magnet clutch

· Form of components and specifications may vary depending on models.

---

# Control box

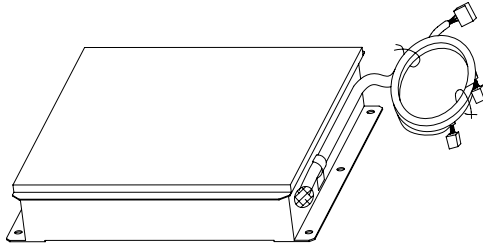

· Form of components and specifications may vary depending on models.

# Cabin controller

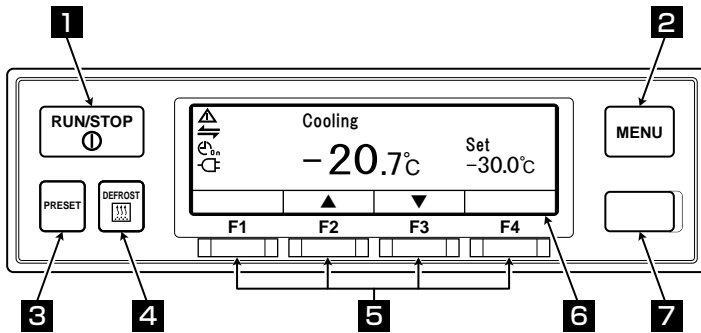

## ■ 2-compartment model

	A	Cooling	B	Heating
	Set	-30.0°C		20.0°C
	Ret	-20.7°C		10.6°C
	A Setting		B Setting	

6





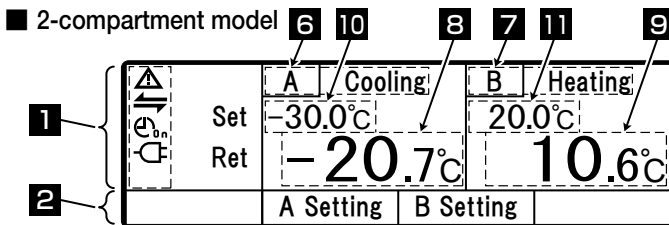
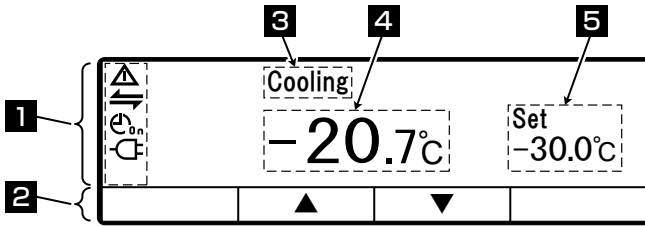

<b>1</b>	RUN/STOP switch	Starts and stops the refrigeration unit.
<b>2</b>	MENU switch	Selects the normal display screen or the menu display screen. Displays the screen while the refrigeration unit is stopped.
<b>3</b>	PRESET switch	Selects the normal display screen or the preset display screen.
<b>4</b>	DEFROST switch	Starts the manual defrost.
<b>5</b>	FUNCTION switches 1 - 4	Functions corresponding to respective setting screens are allocated.
<b>6</b>	LCD	Displays the inside compartment temperature, setting temperature, state of operation, etc.
<b>7</b>	USB terminal (Type B)	Used to read/write data.

## Digital display area



### Description of monitor display item

- 1** Monitor displays following items corresponding to respective setting states. The display items light or blink depending on the operation of respective functions.

-  .....Abnormal display  
Lights or blinks when any error occurs.
-  .....Display for the state of external communication.  
Lights when the operation administration input, such as the remote monitor device, etc., is turned ON.
-  .....Displays for ON/OFF timer.  
Lights when the ON timer and the OFF timer are set simultaneously.
-  .....Displays the ON timer.  
Lights when the ON timer operation is set.
-  .....Displays for OFF timer.  
Lights when the OFF timer operation is set.
-  .....Display for commercial power supply.  
Lights when the unit is connected to the commercial power supply.

- 2** Displays the allocation of function switch corresponding to the screen.

- 
- 3** Displays the operation modes.  
<Display contents> Cooling, Heating, Defrost, Sleep, Stop and Fan.  
\* There is no display when Thermostat is OFF with evaporator fan motor OFF.  
Fan is displayed when Thermostat is OFF with evaporator fan motor ON.  
If temperature is out of adequate range, the Cooling or Heating display blinks.

---

**4** Displays the inside compartment temperature.

**5** Displays the setting temperature.

---

### In case of 2-compartment model

**6** Displays "A" (compartment) and the operation mode of compartment A.

**7** Displays "B" (compartment) and the operation mode of compartment B.

**8** Displays the inside compartment temperature at compartment A.

**9** Displays the inside compartment temperature at compartment B.

**10** Displays the setting temperature at compartment A.

**11** Displays the setting temperature at compartment B.

---

## Protective devices

This refrigeration unit is provided with the following protective devices to ensure the safety of the operators.

(1) Panel, Fan guard

These devices prevent interference with the rotating section (fan motor) during operation.

People who handle this refrigeration unit are requested to understand the functions of these protective devices completely to use it safely. Do not deactivate these protective devices or do not operate the refrigeration unit in the situation that the devices are inactivated. It is most important for safety ensuring to keep functions of the protective devices in normal status continuously.





# 3 Precaution for safety

In this section, necessary safety precautions are provided to prevent accidents resulting in injuries or death, property damages and environment pollution. Read and understand contents of the cautions before starting to use this Refrigeration Unit.





## Signs on safety

Signs and Symbols on safety in this operation manual and the warning labels call the attention of the people who handle this refrigeration unit.

### Signs on safety

Kinds	Description
 <b>DANGER</b>	Indicates high and imminent potentially dangerous situation, which if mis-handle, will result in death, injury, or serious accident such as damage of the refrigeration unit.
 <b>WARNING</b>	Indicates dangerous situation, which if mis-handled, will result in death, serious injury, and serious accident such as damage of the refrigeration unit.
 <b>CAUTION</b>	Indicates potentially dangerous situation, which if mis-handled, will result in minor injury or moderate property damage.

### Symbols

Symbols	Description	Symbols	Description
	Never perform.		Always observe the instructions.
	Disconnect power supply plug from socket.		Never touch.
	Repairs and disassembly must be done only by qualified personnel		

### Other symbol

Other advice for the refrigeration unit is described with the following symbol.

Kind	Description
 NOTE	Useful information for function or performance of equipment

## Precautions

### General precautions

#### **DANGER**



**Do not modify or perform specification change for the refrigeration and vehicle. (This will make refrigeration unit out of warranty.)**

- It may cause a serious accident if customer modify the refrigeration unit or change the specification by himself/herself.

**Do not paint on resinic design panel. (This will make refrigeration unit out of warranty.)**

- Cracking occurs in design panel, which cause a risk of falling down of panel while the vehicle is running.

#### **WARNING**



**Do not start the engine in poorly ventilated places such as an indoor parking lot.**

- Otherwise, it may cause carbon monoxide poisoning due to exhaust gas.

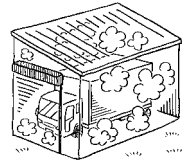

**Do not use the refrigeration unit in the atmosphere which could cause explosion at such place like gas station.**

- Otherwise, it may cause an explosion or a fire.

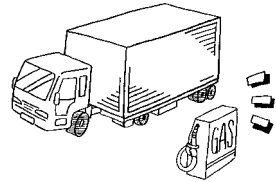

**When it is necessary to charge or retrieve the refrigerant or refrigerating machine oil, be sure to consult the nearest service center.**

- Customer should refrain from attempting to do these on their own. Otherwise, it could result in serious accident.



**Make sure that no one left inside the container before closing the door.**

- He or she might be frozen to death if the refrigeration unit is operated with someone inside.

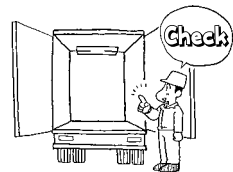

## **WARNING**



**Be sure to carry out the periodic inspections.**

- Otherwise, it may cause troubles of the refrigeration unit or accidents.



## **CAUTION**



**Do not insert sticks or fingers into cold air outlet or inlet.**

- Otherwise, it may cause trouble on the equipment or injury by the fan.



**Do not climb up, hang down or put your leg onto the refrigeration unit.**

- Otherwise, it may cause damage of the equipment or injury.



**Use the refrigeration unit as the equipment for transport refrigeration.**

- Otherwise, it may deteriorate quality of the cargo if it is used for any other purpose.

### **During and after the operation**

## **CAUTION**



**Do not touch the refrigerant pipe during operation or immediately after the operation.**

- Otherwise it may cause burns, as refrigerant pipe will get hot.



**Do not operate the cabin controller while driving the vehicle.**

- Otherwise, it could result in serious accident.

---

## Inspection/Cleaning/Repair

### **WARNING**



**Do not disassemble and repair by yourself.**

- Otherwise, it may cause damages or an electric shock.

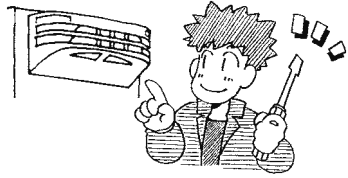

---

### **CAUTION**



**When refrigerant or refrigerating machine oil has spilled, take care not get it in eyes and avoid accidental contact to skin or inhaling or swallowing.**

- Otherwise, it may cause health disorders such as frostbite, loss of eyesight and pneumonia.

---

**Do not wash the refrigeration unit with a steam washer or a high pressure washer.**

- Otherwise, it may cause a rupture due to pressure rise in the refrigeration unit or distortions of the condenser fin.



---

**Before starting inspection or maintenance, be sure to stop the refrigeration unit by turning the “RUN/STOP” switch to OFF, disconnecting the battery terminals and the fan motor connectors.**

- Otherwise, it may cause injury or an electric shock due to unexpected start.



---

**When inspecting or cleaning the refrigeration unit, apply the parking brake and put chocks under wheels.**

- Otherwise, the vehicle may start to move, causing injury or accident.
-

## Loading

### **WARNING**



**Do not load the volatile or inflammable cargos in the container.**

- Otherwise, it may cause an explosion or a fire.



### **CAUTION**



**Cool down or heat up the cargos to the designated temperature in advance with other refrigerating device.**

- If the cargos are not kept in the designated temperature, it may deteriorate quality of the cargos due to inside container temperature rise.

**Waterproof the cargos if they need to be.**

- Water may drip or splash from the evaporator unit.

**When stacking cargos, secure safety.**

**When loading fragile cargos, use appropriate protective materials.**

- It could damage cargos or cause injury or accident.

---

## Handling of electric equipment and power codes

### **WARNING**



- Do not directly splash water on the electric equipment or wash them with water.
- Never touch the electric equipment or operate the switches with wet hands.
- Otherwise, it may cause troubles of electric circuit, or an electric shock.

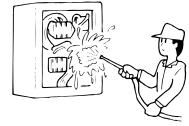

---

## Reinstallation of the refrigeration unit

### **WARNING**



- User should not attempt to move the refrigeration unit to another vehicle. When it is necessary, consult your nearest dealer.
- The refrigeration unit may fall down and cause a serious accident due to improper installation or insufficient strength if the work is performed by the customer.

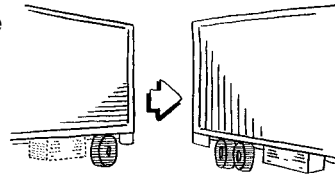

---

## Modification of refrigeration unit and specification change

### **WARNING**



- Do not modify the refrigeration unit or change the specification.
- It may cause a serious accident if customer modify the refrigeration unit or change the specification by himself/herself.



- Do not use any refrigerant or refrigerating machine oil other than those specified.
- Otherwise, it may cause explosion or fire.

## Emergency measures

### (1) Refrigerant

- **When refrigerant got in your eye**  
Wash your eye with lots of clean running water for more than 15 minutes immediately. Wash rear side of the eyelid as well. Then, consult a physician as soon as possible.
- **When refrigerant comes in contact with your skin**  
Take off wet clothes, shoes and socks immediately, as it may cause frostbite if you touch the refrigerant. Wash the part well with lots of water. If you still have irritation, consult a physician as soon as possible.
- **When inhaling evaporated gas**  
When someone inhaled high level of gas, move to the place with fresh air immediately holding him/her with a blanket or the like to keep warm. Then consult a physician as soon as possible. When he/she does not breathe or hardly breathe, loosen his/her clothes and practice artificial respiration after securing the air passage. Depending on the circumstance, have him/her inhale oxygen and take him/her to a physician as soon as possible.
- **When swallowing refrigerant**  
Do not throw up by force and consult a physician as soon as possible.
- \* **Precautions for physician**  
Use of Catecholamine system medicine such as adrenaline and so on may cause heart arrhythmia. Therefore it is required to use only for the emergency life-sustaining treatment with special consideration.

### (2) Compressor oil

- **When compressor oil got in your eye**  
Wash your eye with lots of clean running water for more than 15 minutes immediately. Wash rear side of the eyelid as well. If you still have irritation, consult a physician as soon as possible.
- **When compressor oil comes in contact with your skin**  
Wash the part with lots of water and soap well and apply conditioning cream on it.
- **When inhaling evaporated gas**  
Move to the place with fresh air immediately holding him/her with a blanket or the like to keep warm. Then consult a physician if it is necessary. When he/she does not breathe or hardly breathe, loosen his/her clothes and practice artificial respiration after securing the air passage. Depending on the circumstance, have him/her inhale oxygen and take him/her to a physician as soon as possible.

### 3 Precaution for safety

- **When swallowing compressor oil**

Do not throw up the oil by force and consult a physician as soon as possible. When inside the mouth is contaminated, wash it well with water. (When throwing up the oil by force, it easily gets into air passage and causes high fever if it gets into lung. It may cause hardly incurable hemorrhagic pneumonia accordingly.)



## Handling of warning labels

- Important precautions are stated on the warning labels. Never operate the refrigeration unit unless fully understanding the meanings of the warning labels. When you found some difficulties to understand, contact your nearest dealer.
- Always keep the labels in good condition to read. Do not peel off, tear off or damage the labels or do not wipe with solvent or paint them.
- When the labels become illegible, purchase them from your nearest dealer and change them.

### Refrigeration unit

#### ■ Top view

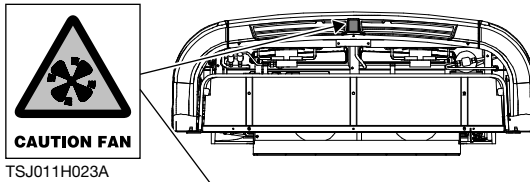

#### ■ Back view

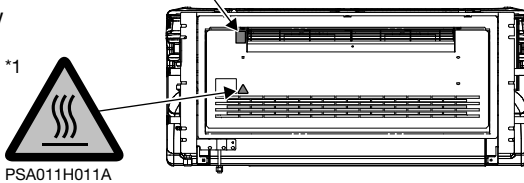

#### ■ Front view

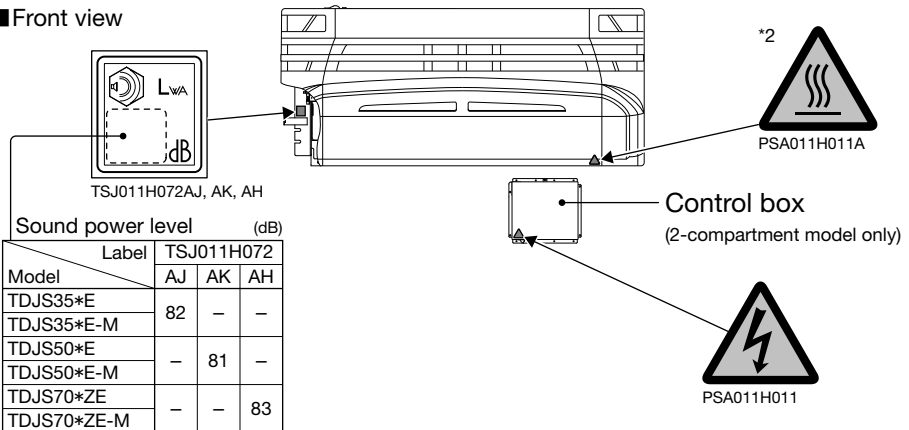

\*1 Warning about high temperature sections on the hot gas pipe and the drain pan

\*2 Warning about high temperature sections on the pipe cover and the discharge pipe in the unit

### 3 Precaution for safety

#### ■ Right side view inside

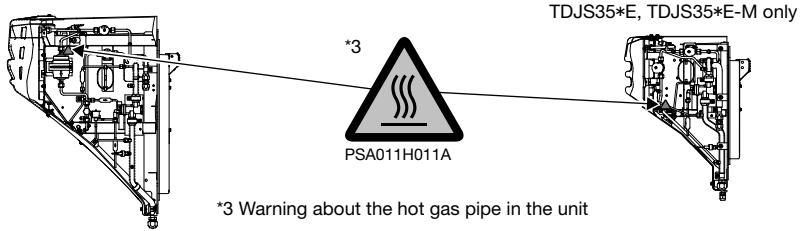

#### ■ Left side view inside

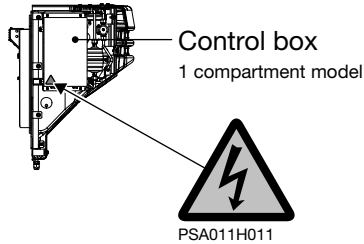

#### Rear evaporator unit

##### ■ Bottom view

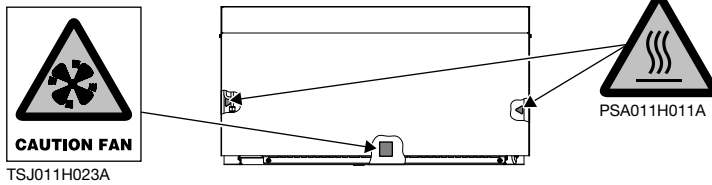

#### Compressor

##### ■ CS55

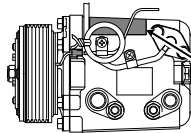

##### ■ CSA90, CSA150

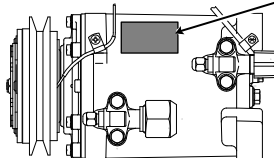

警告 注意		ケガの恐れあり INJURY HAZARD 作業前に全ての電源を切り、保護具を着用すること
		やけどの恐れあり BURN HAZARD 運転中、停止直後は素手で触らないこと
		爆発、火災の恐れあり EXPLOSION OR FIRE HAZARD 作業前に冷媒ガスを完全に抜くこと 指定冷媒、油以外の使用や真空運転をしないこと
		回転物注意 DO NOT TOUCH ROTATING BODIES

ASA011H012

---

## Prevention of start during inspection work

When several people are working simultaneously for inspection, it is necessary to protect them from getting injured by accidental start of operation.

In such occasion, place a tag stating "WORKING" on the cabin controller.

---

## Clothing and protective equipment

Wear proper clothing and protective equipment to prevent from getting injured.

- Wear the clothing such as long sleeves, long pants, gloves and eye protections.
- Do not wear accessories such as necklaces or a necktie to prevent it from getting rolled in. Fasten the cuffs firmly.

---

## When abnormal conditions are detected

Refer to "9 For emergency" when abnormal conditions are detected. Please contact your nearest dealer when it is too difficult to handle.

---

## For emergency

Contact the public agencies such as the police or the fire department immediately when an accident could result in serious injury, death, serious property damage or environmental damage occurred. Contact your nearest dealer to prevent second accident.

# 4 Initial setting

## Display and function of main menu

If you press the “MENU” switch once on the “Normal display screen” which is displayed when the refrigeration unit is stopped or operating, the display changes to the “Main menu” screen. Each push on “F2 (▲)” or “F3 (▼)” switch changes the display so that various settings can be made. In the following figure, “F2” switch changes sequence clockwise while “F3” switch changes counter clockwise.

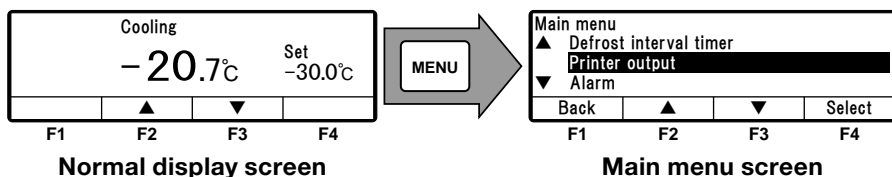

### • Main menu items

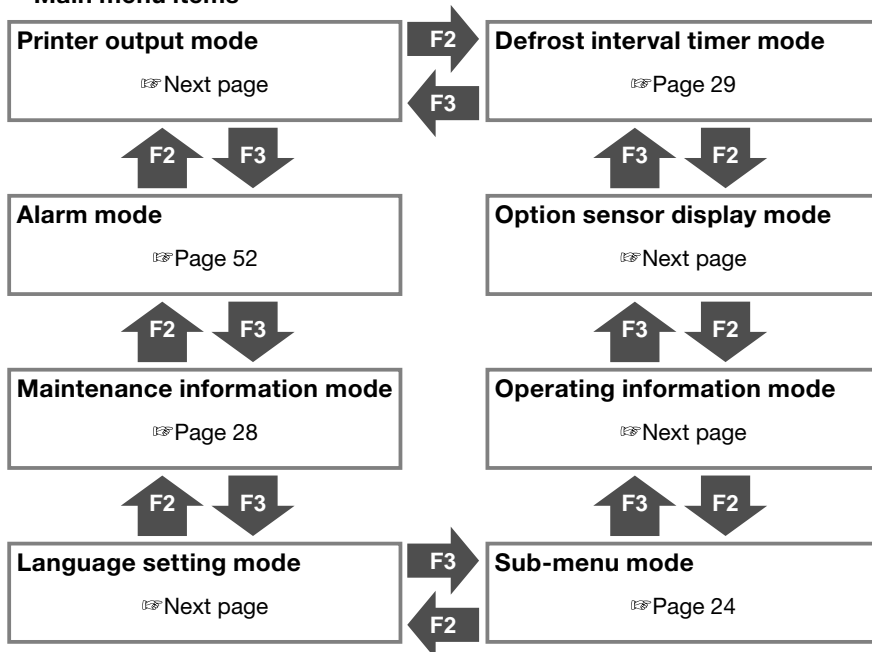

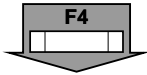

If you press “F4 (Select)” switch on each MAIN menu screen on previous page, the display changes to the following screens.

Printer output			
Printout period	12hr		
Temp range	±30°C		
Center temp	0°C		
Back	▲	▼	Next

### Printer output setting mode

The temperature graph is printed in this mode. Provide a printer to print the graph. (Option)

Alarm			
E010	16 Jan 2018 07:10		
E016	15 Jan 2018 08:15		
E013	30 Nov 2017 10:30		
Back		Clear	

### Alarm display mode

Up to 3 error codes and dates/times of alarm occurred are displayed. These are cleared by pressing “F3 (Clear)” switch. (☞ Page 52)

Maintenance information			
Total operation time1/2120hr			
Back			Next

### Maintenance information display mode

Operation time and number of operations of each device are displayed in this mode. (☞ Page 28)

Language setting			
▲ German			
English			
▼ French			
Back	▲	▼	Set
F1	F2	F3	F4

### Language setting mode

Selects a language (English, French, Italian, Swedish or German). Press “F2 (▲)” or “F3 (▼)” switch to select a language, and finalize the selection by pressing “F4 (Set)” switch.

Sub-menu			
▲ Controller sound setting			
Calendar and clock setting			
▼ Set On Timer			
Back	▲	▼	Select

### Sub-menu selection mode

Functions of the controller operability, or other, are displayed and set in this mode. (☞ Page 24)

Operating information			
HP	2560kPa	TD	125°C
LP	150kPa	REV	---
AT	----	State	Cooling
Back			

### Operation information display mode

State of operation is displayed in this mode. In case of 2-compartment model, the “State” displays 2 letters such as **Cl** (Cooling), **Ht** (Heating), **Df** (Defrost), **Sl** (Sleep), **St** (Stop), **Fl** (Failure) or **Fn** (Fan), starting from the compartment **A** to **B**.

* In case of Heating and Cooling on 2-compartment model	State	Cl Ht

Option sensor display			
-20.7°C			
Back			

### Option sensor temperature display mode

When the optional sensor is installed, the sensor temperature is displayed in this mode. Unless the option sensor is installed, it displays “Lo”.

Current setting			
3.0hr			
Back	▲	▼	Set

### Defrost interval timer setting mode

The defrost interval is displayed and set in this mode. It is set at “3.0hr” at the shipping from factory. (☞ Page 29)

## Display and function of Sub-menu

On the “Sub-menu”, the screen changes in the following order at each push on “F2 (▲)” or “F3 (▼)” switch. In the following figure, “F2” switch changes sequence clockwise while “F3” switch changes counter clockwise.

**NOTE**

- If “MENU” switch is pressed for more than 1 second on the way of changing setting, the display returns to the normal display screen, and the change content is not reflected. The change content will be lost also when the setting change is aborted on the way.

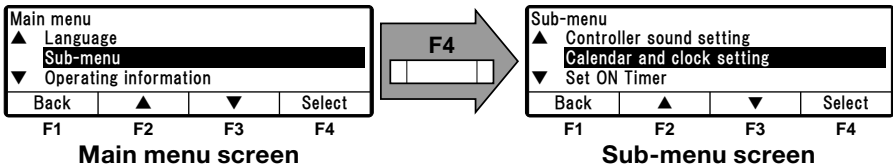

• Sub-menu items

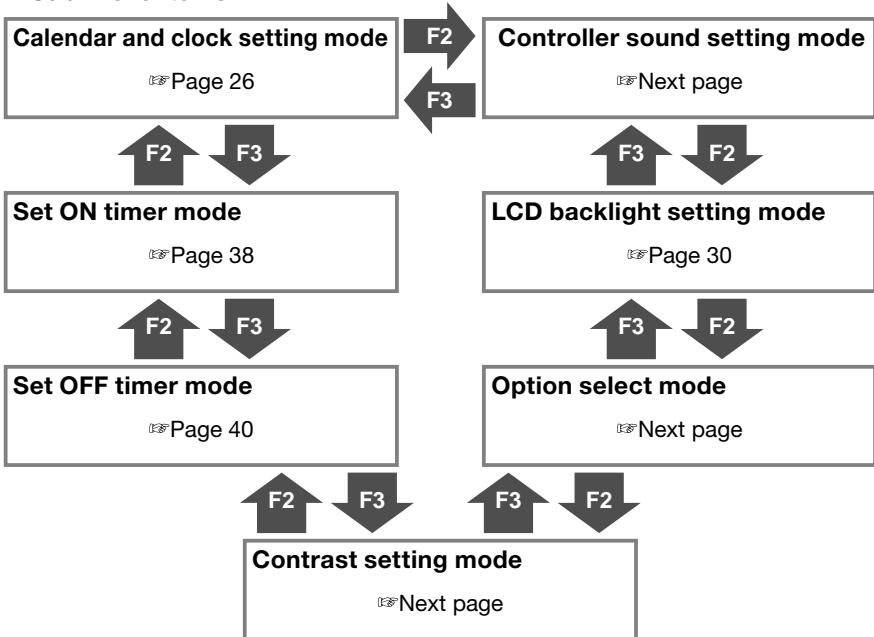

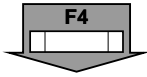

If “F4 (Select)” switch is pressed on each Sub-menu screen on previous page, the display changes to following screens.

Calendar and clock setting			
01	Jan	2018	00:00
Back	▲	▼	Next

### Calendar and clock setting mode

Date, Month, Year and current time are set in this mode.

(☞ Page 26)

Set ON timer			
ON timer disable			
Back	Enable	Disable	Set

### Set ON timer mode

Date and time to start the refrigeration unit automatically is set in this mode.

(☞ Page 38)

Set OFF timer			
OFF timer disable			
Back	Enable	Disable	Set

### Set OFF timer mode

Date and time to stop the refrigeration unit automatically is set in this mode.

(☞ Page 40)

Contrast setting			
Back	▲High	▼Low	Set
F1	F2	F3	F4

### Contrast setting mode

Screen contrast is adjusted in this mode.

Use “F2 (▲)” switch to intensify the contrast or “F3 (▼)” switch to diminish the contrast.

Option select			
Option1 setting		OFF	
Back	Previous	Next	Select

### Option select/set mode

Press “F2 (Previous)” or “F3 (Back)” switch to select options 1 to 8.

Press then “F4 (Select)” switch to change to Option1 (~ 8) setting mode. Press then “F2 (ON)” or “F3 (OFF)” switch to select ON or OFF, and press “F4 (Set)” switch to finalize the selection.

Option1 setting			
OFF			
Back	ON	OFF	Set
F1	F2	F3	F4

LCD backlight setting			
▲ Always ON			
Light SW linked			
▼ Lit at key operation only(20sec)			
Back	▲	▼	Select

### LCD backlight setting mode

LCD backlight is set in this mode.

(☞ Page 30)

Controller sound setting			
ON			
Back	ON	OFF	Set
F1	F2	F3	F4

### Controller sound setting mode

Whether the switch operating sound is turned on or off is set in this mode.

Select ON or OFF by pressing “F2 (ON)” or “F3 (OFF)” switch, and finalize the selection by pressing “F4 (Set)” switch.

## Setting the calendar and clock (Date, Month, Year)

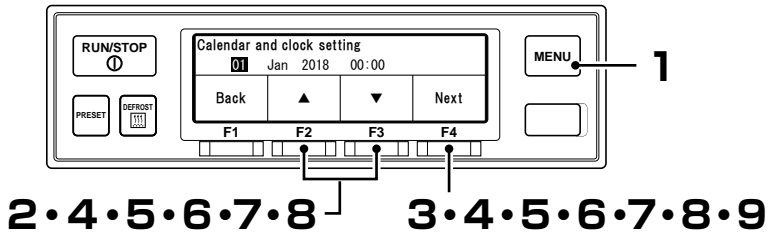

**1** Press “MENU” switch.

⇒ The display changes to “Main menu” screen.

**2** Press “F2 (▲)” or “F3 (▼)” switch till “Sub-menu” screen is displayed.

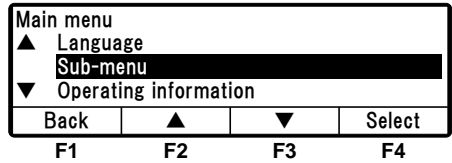

**3** Press “F4 (Select)” switch to change to “Sub-menu” screen (Right figure).

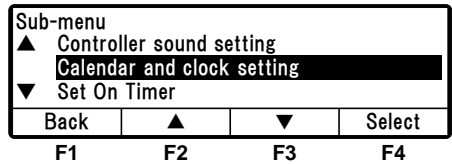

**4** Press “F4 (Select)” switch to change to “Calendar and clock setting” mode (Right figure).

⇒ Press “F2 (▲)” or “F3 (▼)” switch to adjust at current date.

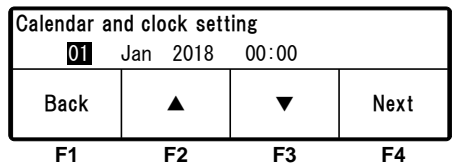

**5** Press “F4 (Next)” switch.

⇒ Press “F2 (▲)” or “F3 (▼)” switch to adjust at current month.

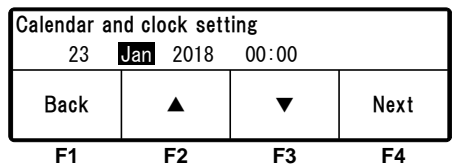

**6** Press “F4 (Next)” switch.

⇒ Press “F2 (▲)” or “F3 (▼)” switch to adjust at current year.

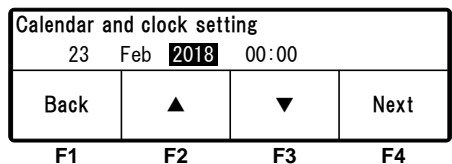



**7 Press “F4 (Next)” switch.**

⇒ Press “F2 (▲)” or “F3 (▼)” switch to adjust at current time (Hour).

**NOTE**

- Time is displayed in the 24-hour scale. If it is “7 PM”, set as “19:00”.

Calendar and clock setting				
23		Feb	2018	00:00
Back	▲	▼	Next	
F1	F2	F3	F4	

**8 Press “F4 (Next)”.**

⇒ Press “F2 (▲)” or “F3 (▼)” switch to adjust at current time (Minute).

Calendar and clock setting				
23		Feb	2018	09:00
Back	▲	▼	Set	
F1	F2	F3	F4	

**9 Press “F4 (Set)” switch.**

⇒ The setting is completed, and the display returns to the screen of Step 3, “Sub-menu”.

## Displaying the maintenance information

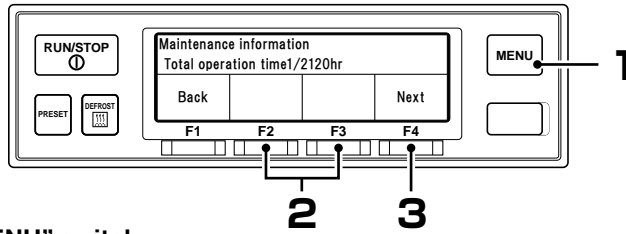

**1** Press “MENU” switch.

⇒ The display changes to the “Main menu” screen.

**2** Press “F2 (▲)” or “F3 (▼)” switch till the display changes to the “Maintenance information” mode.

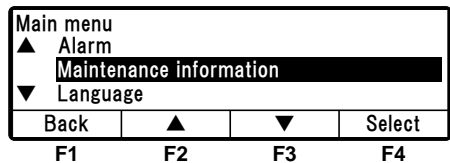

**3** Press “F4 (Select)” switch. [In case of TDJS]

⇒ “Total operation time” is displayed.

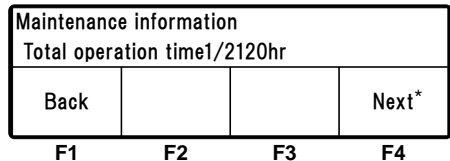

\* “Next” is displayed only when there is any item which can be displayed.

## Display of Maintenance required

- If the operation time or number of operations reaches the Maintenance required time on each device, this screen (Right figure) is displayed for 10 seconds after the start of operation of the refrigeration unit.
- Where there is any part requiring maintenance, if you press “F4 (Next)” switch after the display of Step 3 above on the Maintenance information screen, the part requiring maintenance is displayed.
- If you press “F2 (Reset)” switch after replacing the part, the operation time and the number of START/STOP cycles are cleared.

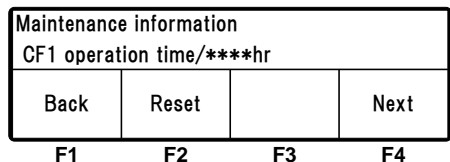
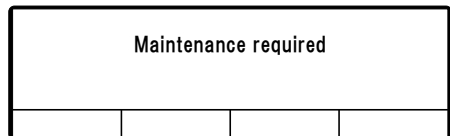

## Setting the defrost interval

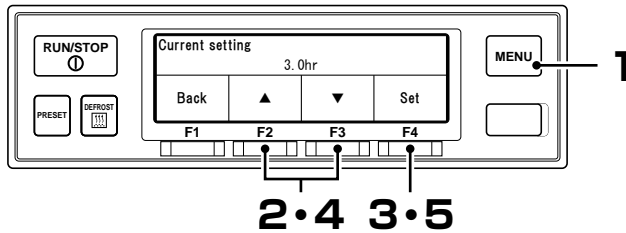

### 1 Press "MENU" switch.

⇒ The display changes to "Main menu" screen.

### 2 Press "F2 (▲)" or "F3 (▼)" switch till the display changes to "Defrost interval timer".

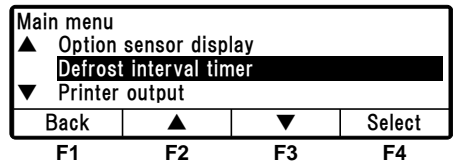

### 3 Press "F4 (Select)" switch.

⇒ Current setting of "Defrost interval time" is displayed.

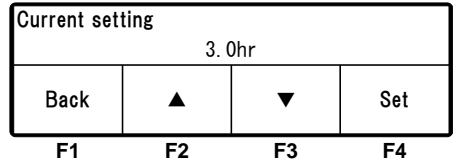

### 4 Press "F2 (▲)" or "F3 (▼)" switch to select a setting time.

#### NOTE

- The defrosting can be set at OFF, or at every 30-minute in the range of from 0.5 hours to 6 hours.

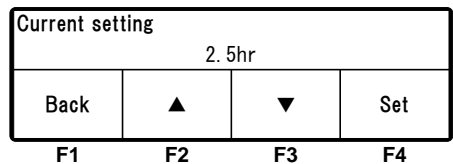

### 5 Press "F4 (Set)" switch.

⇒ The setting completes, and the display returns to the screen of Step 2, "Main menu".

## Setting LCD backlight

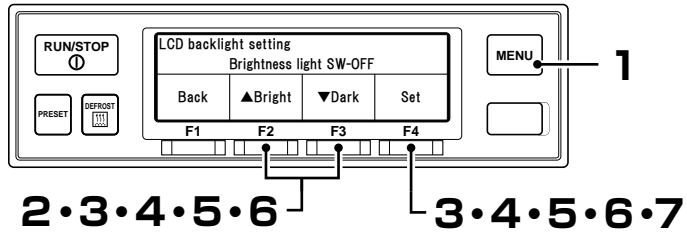

**1** Press “MENU” switch.

⇒ he display changes to “Main menu” screen.

**2** Press “F2 (▲)” or “F3 (▼)” switch till the display changes to “Sub-menu” screen (Right figure).

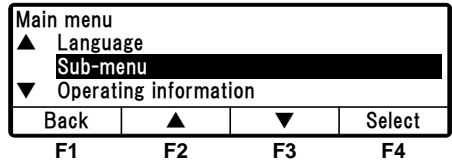

**3** Press “F4 (Select)” switch to change to “Sub-menu” screen. Press “F2 (▲)” or “F3 (▼)” switch till the display changes to “LCD backlight setting” screen (Right figure).

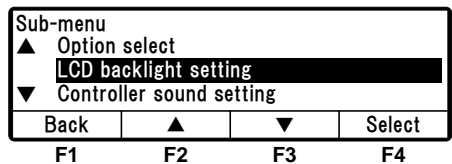

**4** Press “F4 (Select)” switch.

⇒ Press “F2 (▲)” or “F3 (▼)” switch to select the following LCD backlight setting.

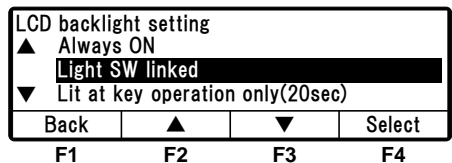

- [Light SW linked]** : Lights interlocked with the lighting of vehicle's light.
- [Lit at key operation only(20sec)]** : Lights for 20 seconds only when the switch is operated.
- [Always OFF]** : Always turning off the light.
- [Always ON]** : Always lighting.

## 5 Press “F4 (Select)” switch. 【Light SW linked】

- ⇒ Adjust the brightness of the LCD backlight, when the vehicle’s light is OFF, pressing “F2 (▲Bright)” or “F3 (▼Dark)” switch.  
⇒ Step 6

【Lit at key operation only(20sec)】

- ⇒ Step 7

【Always OFF】

- ⇒ Step 7

【Always ON】

- ⇒ Adjust the brightness of the LCD backlight for Always ON by pressing “F2 (▲Bright)” or “F3 (▼Dark)” switch. ⇒ Step 7

## 6 Press “F4 (Next)” switch. 【Light SW linked】

- ⇒ Adjust the brightness of the LCD backlight, when the vehicle’s light is ON, pressing “F2 (▲Bright)” or “F3 (▼Dark)” switch. ⇒ Step 7

## 7 Press “F4 (Set)” switch.

- ⇒ The setting completes, and the display returns to “Sub-menu” screen of Step 3.

LCD backlight setting			
Brightness of light SW-OFF			
Back	▲Bright	▼Dark	Next
F1	F2	F3	F4

LCD backlight setting			
Lit at key operation only(20sec)			
Back			Set
F1	F2	F3	F4

LCD backlight setting			
Always OFF			
Back			Set
F1	F2	F3	F4

LCD backlight setting			
Brightness of always ON			
Back	▲Bright	▼Dark	Set
F1	F2	F3	F4

LCD backlight setting			
Brightness of light SW-OFF			
Back	▲Bright	▼Dark	Set
F1	F2	F3	F4

## 5 Operation

### **WARNING**



**Do not operate the refrigeration unit in the place where there is a risk of combustible gas leakage.**

- Otherwise, it may cause a fire.
- 

**Do not touch the electric devices with wet hands.**

- Otherwise, it may cause an electric shock.
- 



**When driving the unit with the vehicle's engine in a building, sufficient ventilation must be provided.**

- Otherwise, it may cause oxygen deficiency due to exhaust gas.
-

## Starting the operation

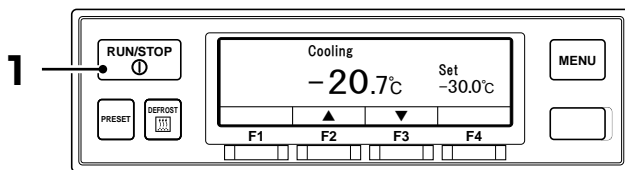

- 1 Press “RUN/STOP” switch.  
(The refrigeration unit is turned “ON”.)

⇒ LCD indicates the inside compartment temperature and the setting temperature.

When the unit is connected to the commercial power supply, LCD indicates the display for commercial power supply.

## Stopping the operation

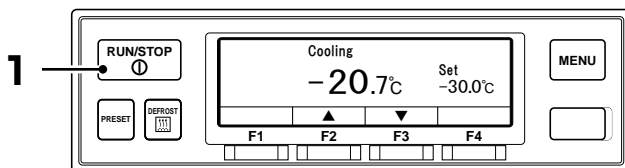

- 1 Press “RUN/STOP” switch.  
(The refrigeration unit is turned “OFF”.)

### NOTE

- If the vehicle driving engine is started in the state that the standby motor is stopped and the refrigeration unit is connected to the commercial power supply, the buzzer sounds to remind the need to disconnect the power supply.

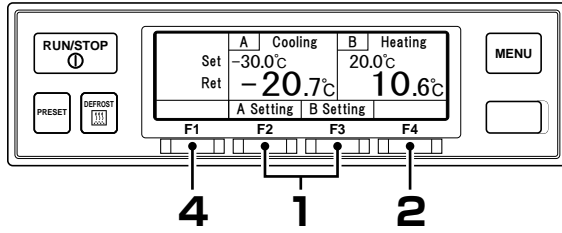

## Suspending (sleep) the compartment operation (2-compartment model)

- 1** On the normal display screen (Right figure), press “F2 (Compartment A setting)” or “F3 (Compartment B setting)” switch to select the compartment of which operation is suspended.

	A	Cooling	B	Heating
Set	-30.0°C		20.0°C	
Ret	-20.7°C		10.6°C	
	A Setting		B Setting	
F1	F2	F3	F4	

- 2** Press “F4 (Sleep)” switch.

⇒ When the operation is suspended at the selected compartment (the screen of Step 3), press “F4 (Operate)” switch.

Set point			
-30.0°C			
Back	▲	▼	Sleep
F1	F2	F3	F4

- 3** “Sleep” is displayed.

⇒ If “F4 (Operate)” switch is pressed, the display of “Sleep” extinguishes. (the screen of Step 2)

Set point			
-30.0°C			Sleep
Back			Operate
F1	F2	F3	F4

- 4** Press “F1 (Back)” switch.

⇒ Operation/Suspension is completed at the selected compartment, and the display returns to the normal display screen.

	A	Sleep	B	Heating
Set			20.0°C	
Ret			10.6°C	
	A Setting		B Setting	
F1	F2	F3	F4	

**NOTE**

- It is impossible to suspend operation at all compartments.



## Setting the temperature

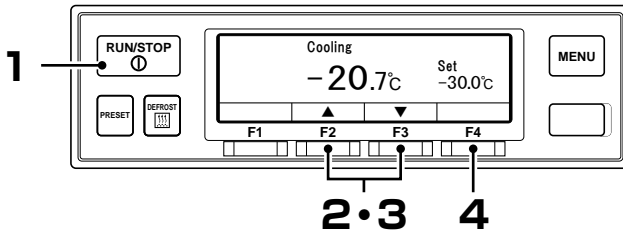

**1** Start the operation of refrigeration unit. (☞ Page 33)

**2** [In case of 2-compartment mode]  
On the normal display screen  
(Right figure), press “F2 (A setting)”  
or “F3 (B setting)” switch.

	A	Cooling	B	Heating
Set	-30.0°C		20.0°C	
Ret	-20.7°C		10.6°C	
	A Setting		B Setting	
	F1	F2	F3	F4

**3** Press “F2 (▲)” or “F3 (▼)”  
switch, and set a temperature.

[In case of 2-compartment mode]  
“F4 (Sleep)” is displayed.

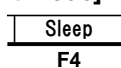

Set point			
-30.0°C			
Back	▲	▼	
F1	F2	F3	F4

### NOTE

- Each push on “F2” switch increases the value by 0.5 while the value decreases by 0.5 at each push on “F3” switch. If the switch is held down, the value changes continuously.

**4** Press “F4 (Set)” switch.

⇒ The setting completes, and the display returns to the normal display screen.

Set point			
-25.5°C			
Back	▲	▼	Set
F1	F2	F3	F4

### NOTE

- The “Preset” function is provided, with which it can be selected from 4 setting temperatures which have already been registered. (Next page)

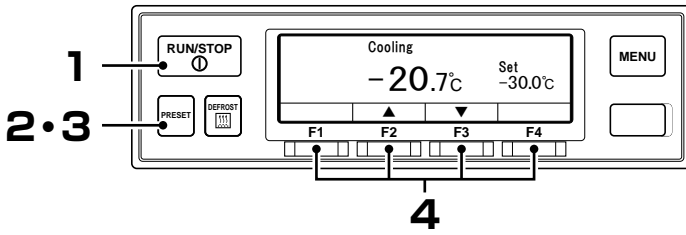

## Setting the preset temperature

1 Start the refrigeration unit. (Page 33)

2 [In case of 2-compartment model] Press the “Preset” switch.

⇒ In the “Preset (Zone selection)” mode (Right figure), press “F2 (Zone A)” or “F3 (Zone B)” switch to select the compartment of which the setting temperature is changed.

⇒ The display changes to the mode screen of Step 3 below. Further procedure is same as in the case of 1-compartment model.

Preset(Zone selection)			
Back	Zone A	Zone B	
F1	F2	F3	F4

3 [In case of 1-compartment model] Press the “Preset” switch.

⇒ The display changes to the preset setting screen. Right figure shows the setting values at the shipping from factory.

Current setting			
-30.0°C			
-18.0°C	-5.0°C	5.0°C	20.0°C
F1	F2	F3	F4

4 Press “F1 (~ F4)” switch.

⇒ Desired preset temperature is set, and the display returns to the normal display screen.

Current setting			
-18.0°C			
-18.0°C	-5.0°C	5.0°C	20.0°C
F1	F2	F3	F4

4 [Preset registration of current setting temperature] Hold down “F1 (~ F4)” switch for 3 seconds.

⇒ The preset temperature is registered, and the display returns to the normal display screen.

Current setting			
-30.0°C			
-30.0°C	-5.0°C	5.0°C	20.0°C
F1	F2	F3	F4

## Manual defrost operation

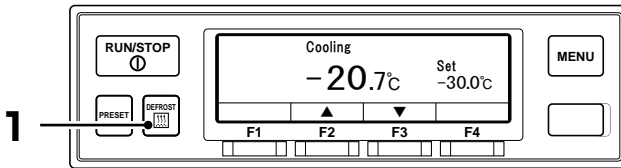

### Starting the manual defrost operation

- 1 Press the “DEFROST” switch once during cooling operation.

⇒ The defrost operation starts.

#### NOTE

- The defrost operation may not start when the inside container temperature is higher.

### Ending the manual defrost operation

If the defrost operation completes, it returns to the cooling operation.

If it is necessary to interrupt the defrost operation and to return to the cooling operation, press the “DEFROST” switch once more.

If the “RUN/STOP” switch is turned “OFF”, it interrupts the defrost operation and stops the operation of refrigeration unit.

#### NOTE

- The manual defrost operation can be made also during the thermostat OFF stop.
- The manual defrost operation cannot be made during the operation stop and the heating operation.

## Setting the ON timer

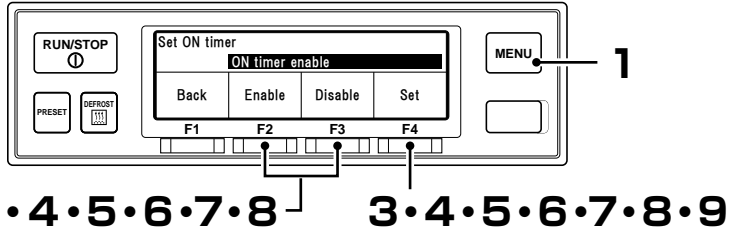

### 1 Press "MENU" switch.

⇒ The display changes to "Main menu" screen.

### 2 Press "F2 (▲)" or "F3 (▼)" switch till the display changes to "Sub-menu" screen (Right figure).

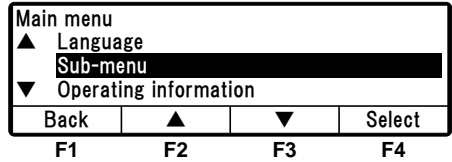

### 3 Press "F4 (Select)" switch to change to "Sub-menu" screen. Press "F2 (▲)" or "F3 (▼)" switch till the display changes to "Set ON Timer" screen (Right figure).

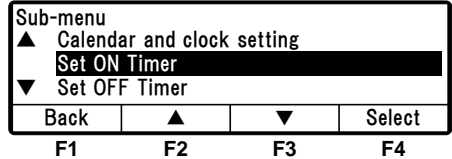

### 4 Press "F4 (Select)" switch to change to "ON timer enable" mode (Right figure).

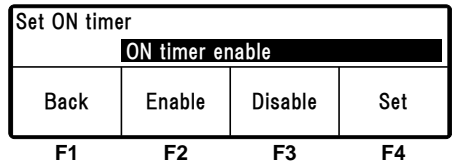

⇒ If Enable is selected by pressing "F2 (Enable)" switch, go to Step 5.

⇒ When Disable has been selected by pressing "F3 (Disable)" switch, if "F4 (Set)" switch is pressed, the display returns to the screen of Step 3.

### 5 Press "F4 (Set)" switch.

⇒ Press "F2 (▲)" or "F3 (▼)" switch, and set the time (Date) of Set ON timer.

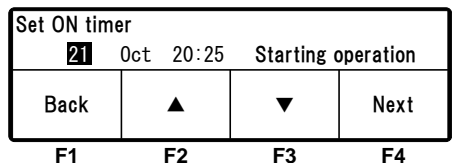

**6 Press “F4 (Set)” switch.**

⇒ Press “F2 (▲)” or “F3 (▼)” switch, and set the time (Month) of Set ON timer.

Set ON timer			
22	Oct	20:25	Starting operation
Back	▲	▼	Next
F1	F2	F3	F4

**7 Press “F4 (Next)” switch.**

⇒ Press “F2 (▲)” or “F3 (▼)” switch, and adjust the time (Hour) of Set ON timer.

Set ON timer			
22	Oct	23:25	Starting operation
Back	▲	▼	Next
F1	F2	F3	F4

**NOTE**

- Time is displayed in the 24-hour scale. If it is “7 PM”, set as “19:00”.

**8 Press “F4 (Next)” switch.**

⇒ Press “F2 (▲)” or “F3 (▼)” switch, and adjust the time (Minute) of Set ON timer.

Set ON timer			
22	Oct	23:30	Starting operation
Back	▲	▼	Set
F1	F2	F3	F4

**9 Press “F4 (Set)” switch.**

⇒ The setting completes, and the display returns to the screen of Step 3, “Sub-menu”.

**NOTE**

- When operating the unit with the ON timer using commercial power supply, confirm that the commercial power supply is connected to the refrigeration unit.
- Take note that the refrigeration unit starts the operation automatically at the setting time when the ON timer is set.

## Setting the OFF timer

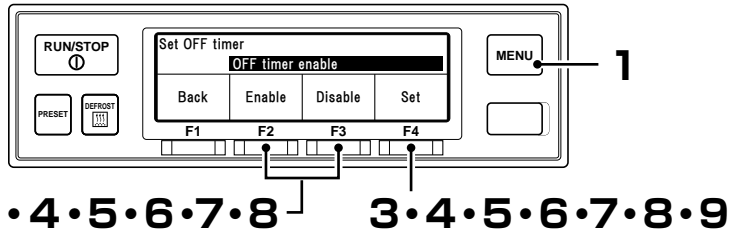

**1** Press “MENU” switch.

⇒ The display change to “Main menu” screen.

**2** Press “F2 (▲)” or “F3 (▼)” switch till the display changes to “Sub-menu” screen (Right figure).

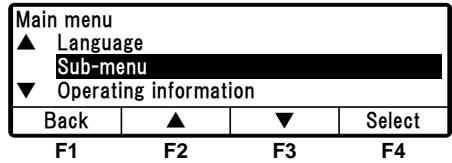

**3** Press “F4 (Select)” switch to change to “Sub-menu” screen. Press “F2 (▲)” or “F3 (▼)” switch till the display changes to “Set OFF Timer” screen (Right figure).

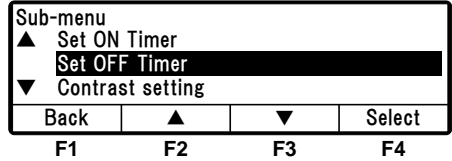

**4** Press “F4 (Select)” switch to change to “Set OFF timer” mode (Right figure).

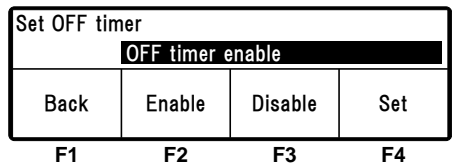

⇒ If Enable is selected by pressing “F2 (Enable)” switch, go to Step 5.

⇒ When Disable has been selected by pressing “F3 (Disable)” switch, if “F4 (Set)” switch is pressed, the display returns to the screen of Step 3.

**5** Press “F4 (Set)” switch.

⇒ Press “F2 (▲)” or “F3 (▼)” switch, and set the time (Date) of Set OFF timer.

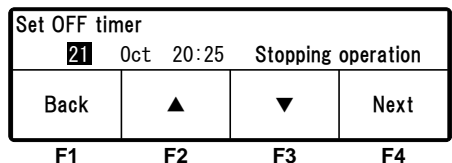

**6 Press “F4 (Set)” switch.**

⇒ Press “F2 (▲)” or “F3 (▼)” switch, and set the time (Month) of Set OFF timer.

Set OFF timer			
22	Oct	20:25	Stopping operation
Back	▲	▼	Next
F1	F2	F3	F4

**7 Press “F4 (Next)” switch.**

⇒ Press “F2 (▲)” or “F3 (▼)” switch, and adjust the time (Hour) of Set OFF timer.

Set OFF timer			
22	Oct	23:25	Stopping operation
Back	▲	▼	Next
F1	F2	F3	F4

 **NOTE**

- Time is displayed in the 24-hpur scale. If it is “7 PM”, set as “19:00”.

**8 Press “F4 (Next)” switch.**

⇒ Press “F2 (▲)” or “F3 (▼)” switch, and adjust the time (Minute) of Set OFF timer.

Set OFF timer			
22	Oct	23:30	Stopping operation
Back	▲	▼	Set
F1	F2	F3	F4

**9 Press “F4 (Set)” switch.**

⇒ The setting completes, and the display returns to the screen of Step 3, “Sub-menu”.

 **NOTE**

- Take note that the refrigeration unit stops the operation automatically at the setting time when the OFF timer is set.

# 6 Loading

## Preparation before loading

### CAUTION



Before loading, cool down or heat up inside of the container to the appropriate setting temperature for the transportation of cargoes. Cargoes must be cooled down or heated up to the designated temperature with other refrigeration device in advance.

- Otherwise, it may cause damages of the cargoes or deterioration of the quality. Or it may cause emergency stop of the refrigeration unit.

**1** Cargoes must be cooled down or heated up to the designated temperature with other refrigeration device in advance.

**2** Clean inside of the container.

**3** Perform the inspection of the refrigeration unit and the body\*.  
(👉 Refer to page 45)

\* Check with the body manufacturer for the items to be inspected.

**4** Set the right temperature for transportation of the cargo and cool down or heat up inside of the container to the setting temperature.

(👉 Refer to page 35)

### NOTE

- The temperature inside of the closed container may reach 60°C under a blazing sun. Loading in such a container causes damages or deterioration of the quality. Be sure to cool down inside of the container to the setting temperature before loading.
- When it is hardly cooled down, contact your nearest dealer before loading.



## Loading and unloading

### Loading procedure

1 Stop the cooling operation. (☞ Refer to page 33)

2 Load the cargoes in the container.

Leave a space between the cargo and inner wall of the container as shown in the following figure in order to circulate cool air.

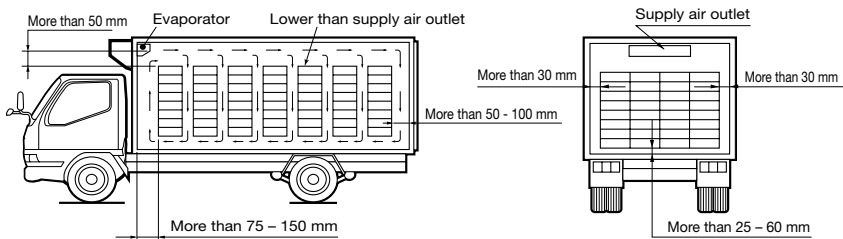

3 Keep the top layer of the cargo as flat as possible.

### CAUTION



**Waterproof the cargoes if they need to be.**

- Water may drip or splash from the evaporator unit.

**When stacking cargoes, secure safety.**

**When loading fragile cargoes, use appropriate protective materials.**

- It could damage cargoes or cause injury or accident.

4 When transporting any cargo to be protected from water damage, cover the cargo placed under the evaporator unit or near its outlet with waterproof sheet.

5 After completing loading, start the operation of the refrigeration unit. (☞ Refer to page 33)

## Unloading

**1** Stop the cooling operation. (👉 Refer to page 33)

**2** Unload the cargoes.

---

 **NOTE**

- Frost forms and accumulates on the evaporator coil while the refrigeration unit is operated during loading or unloading.
  - Since the inside container temperature rises (or falls during cold winter) while the door is kept opened, load or unload as quickly as possible.
  - A curtain helps to prevent ambient air from entering or inside air from escaping during loading or unloading.
-

# 7 Inspection

## Precautions for inspection

Always carry out the following inspections before the operation to prevent any damages of the refrigeration unit before happening.

### **WARNING**



**Do not perform the inspection in the place where the combustible gas leakage may happen.**

- Otherwise, if the gas might leak out, it stays around the refrigeration unit and may catch a fire.



**Be sure to perform daily and periodic inspections.**

- Otherwise, it may cause troubles of the refrigeration unit or accidents.

**The area must be well ventilated when performing the inspection indoors.**

- Otherwise, it may cause oxygen deficiency due to the exhaust gas.

 **CAUTION**



**Sufficient care must be taken for foothold when working at a higher place on a stepladder.**

- If you step off, you may fall down and get injured.
- 

**When leakage of the refrigerant is detected, contact your nearest dealer immediately.**

- Otherwise, it may cause blindness or frostbite.
- 

**Do not start maintenance immediately after stopping operation.**

- Refrigerant pipes are dangerously hot. There is risk of burn if touched carelessly.
- 



**Before starting inspection, be sure to stop the refrigeration unit turning the “RUN/STOP” switch to OFF and disconnect connections to the battery terminals.**

- Otherwise, it may cause injury or an electric shock due to unexpected start.
- 



**Apply the parking brake and put chocks under wheels during inspection.**

- If the vehicle moves, it could cause injury or accident.
-

## Daily inspection

### Inspection of moving sections

- Compressor belt

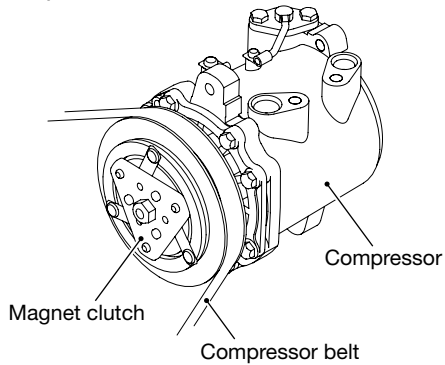

- 1 Visually inspect the compressor belt for defects such as scratch, crack or one-sided wear, etc.

- 2 Check the moving sections for interference with other parts.

#### NOTE

- When there is any abnormal condition or any slack of the belts, surely contact your nearest dealer.

### Inspection of condenser coil

- 1 Check the coil for fouling with dust.

- 2 When the coil is fouled, wash it with a soft brush and water.

#### NOTE

- Dirty coil could deteriorate the refrigeration capacity or cause malfunction of protective devices, which may disable the operation of refrigeration unit. Clean the coil at regular intervals.
- In case of the nose mount type condenser, you need to work at a higher place. Work with sufficient care or consult the nearest service center.

## Periodic inspection

Please ask your nearest dealer to perform periodic inspection to ensure to use the refrigeration unit in the best condition all the time.

Periodic inspection consists of the following items.

1. Inspection at commissioning
2. Monthly inspection
3. Inspection at every 6 months

Check the contents of inspection with the check sheet submitted after the periodic inspection.

# Periodic inspection check sheet

Customer							Customer's signature	
Inspection interval		Serial No.	Van maker			Delivery date Inspection date		
	Compressor kit							
	Refrigeration unit							
	Rear evaporator unit							
Every six months	Every one month	Installation trial operation	Vehicle Model Serial No.	Refrigeration unit installation company		Inspection company Inspector		
Inspection items						Inspection result	Remarks	
<input type="checkbox"/>	<input type="checkbox"/>	<input type="checkbox"/>	Inspection for seal sections of van where refrigeration unit passes through					
<input type="checkbox"/>	<input type="checkbox"/>	<input type="checkbox"/>	Inspection for appropriate piping clamps					
<input type="checkbox"/>	<input type="checkbox"/>	<input type="checkbox"/>	Inspection for secure drain hose connections and adequate clamps					
<input type="checkbox"/>	<input type="checkbox"/>	<input type="checkbox"/>	Inspection for belt slack, parallelism (alignment), and damage					
<input type="checkbox"/>	<input type="checkbox"/>	<input type="checkbox"/>	Inspection for contact with other parts (compressor, pulley, belt, piping, wiring)					
<input type="checkbox"/>	<input type="checkbox"/>	<input type="checkbox"/>	Tightening of installation bolts (refrigeration unit, compressor, compressor head, bracket, magnet clutch, tension pulley, fan motor, fan)					
<input type="checkbox"/>	<input type="checkbox"/>	<input type="checkbox"/>	Inspection for incorrect wiring and for adequate clamps					
<input type="checkbox"/>	<input type="checkbox"/>	<input type="checkbox"/>	Inspection for electrical wiring terminal looseness, wiring, sheath damage					
<input type="checkbox"/>	<input type="checkbox"/>	<input type="checkbox"/>	Relay contact inspection					
<input type="checkbox"/>	<input type="checkbox"/>	<input type="checkbox"/>	Cleaning of refrigeration unit and drain discharge ports					
<input type="checkbox"/>	<input type="checkbox"/>	<input type="checkbox"/>	Inspection for refrigerant system gas leaks (oil leaks)					
<input type="checkbox"/>	<input type="checkbox"/>	<input type="checkbox"/>	Inspection for abnormal noise and abnormal vibration (compressor, magnet clutch, motor, fan, piping)					
<input type="checkbox"/>	<input type="checkbox"/>	<input type="checkbox"/>	Inspection of refrigerant sight glass color and degree of flush					
<input type="checkbox"/>	<input type="checkbox"/>	<input type="checkbox"/>	Confirmation of compressor and magnet clutch start/stop, and condenser fan start/stop with thermostat					
<input type="checkbox"/>	<input type="checkbox"/>	<input type="checkbox"/>	Cooling inspection (indication of digital display temperature, high/low pressure inspection)					
<input type="checkbox"/>	<input type="checkbox"/>	<input type="checkbox"/>	Confirmation of defrosting operation					
<input type="checkbox"/>	<input type="checkbox"/>	<input type="checkbox"/>	Confirmation of high pressure switch operation					
Daily inspection			Operation check					
Seasonal inspection			Cleaning of condenser coil					

---

## Refrigerant and refrigerating machine oil

	TDJS**DAE	TDJS**JE
Refrigerant	R404A	R452A
Compressor oil	Diamond Freeze MA32R	Diamond Freeze MA32R



## 8 Cautions for use

### When operating at a low inside container temperature for a long period of time:

If the refrigeration unit is operated for a long period time with the inside container temperature below 10°C, ice will grow on the drain pan, etc. Stop the operation of refrigeration unit once or twice every week and open up the door on the vehicle body to return the inside of container to ordinary temperature and melt grown ice.

### CAUTION



**Park the vehicle at a flat place and operate the refrigeration unit.**

- Otherwise, the evaporator becomes unable to drain and water overflows in the container, damaging cargoes with water.

### When stopping the refrigeration unit for a long period of time:

To prevent troubles by stopping for prolonged time, operate the refrigeration unit for 15 minutes once every 3 to 4 days.

# 9 For emergency

## Alarm display

- If any error occurs, the abnormal display  lights or blinks on the LCD (the backlight lights or blinks).
- Check the alarm code displayed at the right-hand side of the abnormal display. (If it is a light error, the alarm content at the right-hand side of the alarm code is not displayed.)

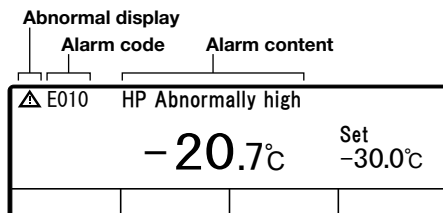

When no error code is displayed at the LCD, change to the alarm display as described below, and check the alarm content.

## Switching "Normal display" and "Alarm display"

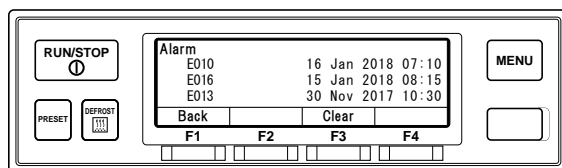

### Switching from "Normal display screen" to "Alarm display mode"

Press once each on the [MENU] switch, [F3(▼)] switch and [F4(Select)] switch. (The display returns to the "Normal display screen" 20 seconds later.)

### Switching from "Alarm display mode" to "Normal display screen"

Press the [F1(Back)] switch 2 times on the extended display of "Alarm display mode". (The screen changes to "Normal display screen" in 20 seconds in case of 1 press.) or hold down [MENU] switch.

## Countermeasures

Refer to "List of alarm codes" for the contents of each alarm code and its countermeasure. (☞ Refer to pages 56 to 57)

### ⚠ CAUTION



**Surely follow the instructions of this operation manual for the countermeasures of the troubles.**

- Otherwise, it may cause injury or an electric shock due to unexpected start.

## Changing the fuse

### ⚠ CAUTION



**Use the designated fuse.**

- If any other fuses are used, it may cause a fire or an electric shock.

**Stop the operation of refrigeration unit with the "RUN/STOP" switch before replacing fuse. Disconnect connections to battery terminals and unplug the power cable.**

- Otherwise, it may cause injury or an electric shock due to unexpected start.

Fuses are mounted in the control box.

### ■Single compartment model

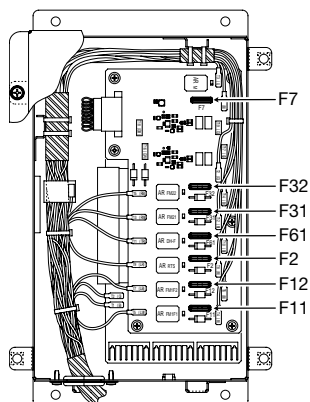

- F2: 10 A (Magnet clutch)
- F7: 10 A (Load power supply)
- F11, 12: 15 A (Evaporator fan motor)
- F31, 32: 15 A (Condenser fan motor)
- F61: 15A (Drain hose heater)

## 9 For emergency

### ■2-compartment model

<TDJS35/50\*E-M>

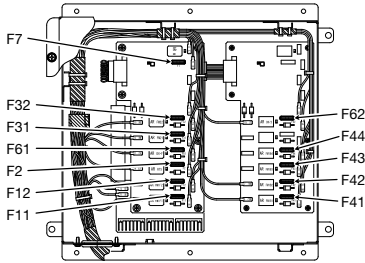

- F2:10A (Magnet clutch)
- F7:10A (Load power supply)
- F11, 12:15A (Front room evaporator fan motor)
- F31, 32:15A (Condenser fan motor)
- F41~44:15A (Rear room evaporator fan motor)
- F61:15A (Front room drain hose heater)
- F62:15A (Rear room drain hose heater)

<TDJS70\*ZE-M>

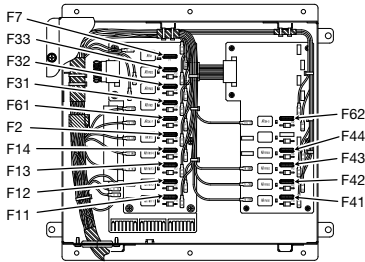

- F2:10A (Magnet clutch)
- F7:10A (Load power supply)
- F11~14:15A (Front room drain hose heater)
- F31~33:15A (Condenser fan motor)
- F41~44:15A (Front room evaporator fan motor)
- F61:15A (Front room drain hose heater)
- F62:15A (Rear room drain hose heater)

## When you contact your nearest dealer

When you contact your nearest dealer for the trouble occurred during operation of the refrigeration unit, give them the following information.

- Company name
- Customer's name
- Company telephone number
- Number of the plate
- Type of the refrigeration unit
- Present location of the vehicle
- Destination
- Kind of cargo
- Setting temperature
- Present inside container temperature
- Specific condition of trouble
- Alarm code displayed in the digital display area.

## Resuming operation after an emergency stop

If a remark "Unit stops" is written in the same column, start the operation in usual procedure after removing causes of the troubles.

### Resuming operation after an emergency stop

- Press the [RUN/STOP] switch on the cabin controller to stop the unit.  
(Confirm that the LCD display is turned off.)
- Press the [RUN/STOP] switch once more to resume the operation of the unit.



## CAUTION



**If the unit stops by the same trouble immediately after the operation is resumed, stop the operation and contact your nearest dealer.**

- Otherwise, it may cause serious damages or accidents.

## List of alarm codes

Alarm Code	Trouble	Countermeasure		Alarm Lamp	Unit Condition
E003	Magnet clutch fuse break	Magnet clutch fuse F2* is blown. Inspect and replace if necessary the fuse F2* in the control box.		On	Unit stops.
E006	Load drive circuit fuse break	Load power supply relay fuse F7* is blown. Inspect and replace if necessary the fuse F7* in the control box.		On	Unit stops.
E010	HP abnormally high	High-pressure switch has tripped. (1) Check if the condenser fan is running. If it is not, check the fuse F3*- or for disconnected wires in the control box. (2) Inspect if the condenser coil is fouled with dirt or mud. If it is, wash it with a soft brush and water.		On	Unit stops.
E013	Td abnormally high	Discharge gas temperature is abnormal. Check for bubbles in the sight glass. If bubbles are observed, ask a service shop for inspection.		On	Unit stops.
E014	Refrigerant shortage	Refrigerant quantity is insufficient. Ask a service shop for inspection.		On	Unit stops.
E016	LPT failure	Broken wire or short-circuit on the low-pressure sensor. Ask a service shop for inspection.		Blinking	Unit operation continues.
E017	HPT failure	Broken wire or short-circuit on the high-pressure sensor. Ask a service shop for inspection.		Blinking	Unit operation continues.
E040	DCS2 shortcircuit (Abnormal stop output)	Short-circuit on the abnormal stop output circuit. Ask a service shop for inspection. Ask a service shop for inspection.		Blinking	Unit operation continues.
E041	DCS1 shortcircuit (Operation output)	Short-circuit on the operation output circuit. Ask a service shop for inspection. Ask a service shop for inspection.		Blinking	Unit operation continues.
E042	DCS3 shortcircuit (Out of range inside container)	Short-circuit on the out of range inside container temperature output circuit. Ask a service shop for inspection.		Blinking	Unit operation continues.
E050	TH sensor failure	Lo (*1)	Short-circuit or poor connector connection on the inside container temperature sensor. Ask a service shop for inspection.	On, or blinking if setting temperature is lower than -10°C.	Unit stops. (Or continuous cooling operation if setting temperature is lower than -10°C.)
		Hi (*1)	Short-circuit on the inside container temperature sensor. Ask a service shop for inspection.		
E057	EVT sensor failure	Broken wire or short-circuit on the evaporator exit temperature sensor. Ask a dealer for inspection.		Blinking	Unit operation continues.
E063	Td sensor failure	Broken wire or short-circuit on the discharge gas temperature sensor at the engine side Ask a dealer for inspection.		Blinking	Unit operation continues.
E067	Td sensor failure (Motor side)	Broken wire or short-circuit on the discharge gas temperature sensor at the motor side Ask a service shop for inspection.		Blinking	Unit operation continues.
E099	Controller communication failure	Cabin controller cannot communicate properly. Ask a service shop for inspection.		On	Unit stops.

\*: Indicates the smallest digit of fuse No.

\*1: Lo or Hi is indicated on the temperature display.

- In case of 2-compartment model, which of the parts that controls compartment is faulty is indicated with the A or B compartment operation indicator.

Alarm Code	Trouble	Countermeasure	Alarm Lamp	Unit Condition
E101	Evaporator fan motor fuse break	Evaporator fan motor fuse F1* is blown. Inspect and replace if necessary the fuse F1* in the control box. In case of 2-compartment model, if the evaporator fan motor fuse at second compartment is abnormal, inspect and replace if necessary the fuse F4* in the control box.	Blinking	Unit operation continues.
E102	Condenser fan motor fuse break	Condenser fan motor fuse F3* is blown. Inspect and replace if necessary the fuse F3* in the control box.	Blinking	Unit operation continues.
E104	Drain hose heater fuse break	Drain hose heater fuse F6* is blown. Inspect and replace if necessary the fuse F6* in the control box.	Blinking	Unit operation continues.
E160	Economizer SV shortcircuit (TDJS70*ZE only)	Short-circuit on the economizer solenoid valve SV6 circuit. Ask a service shop for inspection.	Blinking	Unit operation continues.
E161	Economizer SV shortcircuit	Short-circuit on the fluid line solenoid valve SV5F circuit. Ask a service shop for inspection.	On	Unit stops.
E163	Hot gas line SV shortcircuit	Short-circuit on the hot gas solenoid valve SV1 circuit. Ask a service shop for inspection.	Blinking	Unit operation continues.
E167	Condenser outlet SV shortcircuit	Short-circuit on the condenser exit solenoid valve SV3 circuit. Ask a service shop for inspection.	On	Unit stops.
E168	Liquid bypass SV shortcircuit	Short-circuit on the fluid bypass solenoid valve SV2 circuit. Ask a service shop for inspection.	Blinking	Unit operation continues.

\*: Indicates the smallest digit of fuse No.

- In case of 2-compartment model, which of the parts that controls compartment is faulty is indicated with the A or B compartment operation indicator.



**MITSUBISHI HEAVY INDUSTRIES  
THERMAL SYSTEMS**

---

TRANSPORTATION REFRIGERATION DEPARTMENT

3-1, ASAHI, NISHIBIWAJIMA-CHO, KIYOSU, AICHI, 452-8561, JAPAN

Phone : 052-503-9312